

# Operator Manual

Digital Receiver / Transceiver

## RDR52



Version: 1.16  
Created: 20.12.2021  
Last changed: 07.12.2023

Konstruktion & Musterbau

Burkhard Reuter  
Tel. 034901/67275

Ziegelstraße 54 06862 Dessau-Roßlau  
[www.Reuter-Elektronik.com](http://www.Reuter-Elektronik.com)

# Content

1. Overview.....	4
2. Safety precautions.....	5
3. First steps.....	6
3.1 Unpacking and first-time operation.....	6
3.2 General information on operation.....	6
4. Device description.....	8
4.1 Mechanics.....	8
4.2 Electronics.....	8
4.3 Firmware.....	9
5. Operation.....	10
5.1 Controls and connectors.....	10
5.2 Set values.....	13
5.3 Other displays.....	27
6. Dialogs.....	29
6.1 Setup dialog.....	29
6.2 System dialog.....	36
6.3 Transmitter dialog.....	38
6.4 Microphone dialog.....	40
6.5 RDS dialog.....	43
6.6 GPS dialog.....	44
6.7 WiFi dialog.....	44
6.8 Memory dialog.....	46
6.8.1 Entering an activation code.....	48
6.9 Recorder dialog.....	49
7. Special features.....	52
7.1 Undo function.....	52
7.2 Factory setting.....	52
7.3 Software Upload.....	53
7.4 Display Copy.....	56
7.5 File download.....	57
7.6 DAB Reception.....	58
8. Specifications.....	61
9. Brief introduction to SBSP.....	62

10. Transmitter.....	65
10.1 Overview.....	65
10.2 Specifications.....	66
10.3 Operation.....	67
11. Exciter.....	69
11.1 Overview.....	69
11.2 Specifications.....	69
11.3 Operation.....	69
12. HiFi DAC.....	70
12.1 Specifications.....	70
13. Tips and tricks.....	71
13.1 CW and Digimode reception and operation of the transmitter.....	71
14. Enhancements and Software Updates.....	78
14.1 Vx13.....	78
14.2 Vx14.....	79
14.3 Vx15.....	82
14.4 Vx16.....	86
14.5 Vx17.....	89

# 1. Overview

The Reuter Digital Receiver "RDR52" is a receiver for amplitude and frequency modulated signals in the range from 1 kHz to a maximum of 156 MHz (depending on the configuration). It operates on a completely new principle, Spectrum-Based Signal Processing (SBSP). It allows for an extremely selective filtering and low-noise demodulation with finely tunable parameters without the use of internal or external computers.

The RDR52's basic concept rests upon fully digital signal processing. The amplified and filtered antenna signal is digitized directly (DSR: Direct Sampling Receiver). There is no preceding frequency transformation ("mixing"), no adjustable frequency processing (PLL, VCO, DDS or similar) and no conventional filters (Quartz, Piezo, LC or similar). This results in an extremely linear phase response without additional phase noise or mixing interference, a prerequisite for clean, trouble-free and low-distortion demodulation.

The RDR52's frequency selection ("tuning") is purely computational without any change of frequencies within the device. There is only one free-swinging, very low-noise fixed frequency oscillator. A GPS-based measurement system determines all frequency deviations to within 1 Hz and corrects them without interfering with frequency generation.

The digitized received signals are not processed by a processor by software. The RDR52 does not operate with a DSP, built-in PC or similar high-speed CPUs. PCs or PC accessories (monitor, keyboard, mouse...) can not be connected to the RDR52. All signal processing occurs internally with a maximum of 167 MHz clock frequency in dedicated, parallel-working hardware ("FPGA"). It is programmable by a special firmware ("Configuration") and thus adjustable by updates.

The RDR52 consists of the basic unit with the option of installing two expansion boards. This results in various device configurations, for example: Pure SW receiver, SW receiver with transmitter, or SW plus FM receiver plus transmitter.

In the RDR52, operator guidance is provided by a modern user interface. On a vivid WVGA display (800 x 480 pixels) a variety of elements are displayed, which are operated by touch screen. Additionally, a tuning knob for adjusting settings (e.g. tuning or display brightness) can be utilized. Another mechanical rotary knob allows the volume to be adjusted quickly.

The installation of a high-resolution display with very fast graphical processing introduces possibilities that were previously not or only partially available for small devices (for example spectrum and waterfall display). Digital signal processing enables high-accuracy data. The representations on the RDR52 display even achieve measuring device quality.

The RDR52's spectrum-based signal processing (SBSP) performs four times faster than the well-known FFT (used within spectrum analyzers or SDR receivers with a PC). In addition, high priority was given to an artifact-free image display. Even with extreme settings, there is no flickering of the display (as often seen with very expensive measuring devices). The presentation is always fluid with a high frame rate.

The RDR52 is able to receive the entire LMK or FM range broadband. There are various preselections with low or high pass filters below and above 10 MHz, bandpass filters from 50 to 71 MHz (6 m and 4 m) and 2 broadband but highly selective band filters (SAW) for 87.0 to 110 and 130 to 156 MHz. On the digital level, the selection of a single transmitter occurs by phase-linear filters ("FIR filters") or highly selective using SBSP. A DAB module allows the reception of DAB/DAB+ programs in band III (176 - 240 MHz).

The audio signals are converted into the analog domain by a 24 bit stereo DAC with an 81.92 kSpl/s sampling rate. Two built-in high-efficiency speakers enable stereo output with fine sound quality and volume. The stereo headphone jack provides a high-quality audio signal for headphones or for forwarding to external amplifiers (like a stereo system).

A WiFi / Bluetooth transceiver for coupling to external devices is integrated in the RDR52. The WiFi connection allows data to be exchanged with personal computers or tablets / smartphones (depending on available software for these devices). The firmware of the RDR52 can also be updated via WiFi. The Bluetooth connection enables wireless pairing with external speakers and headsets.

## 2. Safety precautions

**Please always keep the following safety precautions in mind!**

The device is intended for connection to a direct current low voltage. Only use safe power sources such as tested / certified power supplies or fused batteries.

Never connect the device to a voltage other than that specified in the specifications, especially never to mains voltage! The device tolerates polarity reversal (reversal of + and – pole) and overvoltage only in the specified voltage ranges and only for a short time. Disconnect it immediately from the power supply if it has switched itself off or has not switched on due to reverse polarity or overvoltage.

Disconnect the device from the power supply (pull the plug!) if you want to loosen any fastening screw or do any work outside the intended use on the device! The device contains no user-serviceable or user-replaceable parts (e.g., light bulbs or fuses).

The device is intended for indoor use. Avoid excessive moisture, never put liquid filled containers on top of the unit! Should moisture (e.g. spilled drinks) accidentally get on or even get into the device, immediately disconnect the power supply and send the device back to the supplier for inspection!

Observe the permitted temperature range for starting up the device! Do not switch the device on or off again if this range is exceeded or fallen below! The device heats up during operation and gives off this heat via the housing surface. Always set it up so that there is a gap of at least 10 cm between the rear wall and the side walls and other objects! Never place sources of heat such as candles or heaters directly next to, under or on the device! Do not operate the device in direct sunlight!

Always provide a safe placement on a flat, straight and solid base of sufficient carrying capacity! Transport the device only in either solid boxes or crates (for example the shipping container), or transport it by firmly grasping the sides with both hands! The unit can cause an injury in case of a drop under its own weight!

Do not expose this equipment to mechanical stress caused by impact, pressure, vibration or shock which exceed that commonly used in the home with the use of electronic devices! The controls and especially the display are very sensitive to pressure or impact. Never operate an operating element with more force than is necessary and only press the touchscreen with the force required to trigger the function!

If you notice any damage to the device, take it out of service immediately (disconnect the power supply)! If necessary, send it to the supplier for repairs.

Would you like to dispose the device due to damage or because you do not use it anymore, send it back to the supplier or return it to your local waste collection center. Never dispose of the appliance elsewhere, such as household waste. It pollutes our environment!

Only use soft, lint-free and dry cloths to care for and clean the device! Be especially carefully in cleaning the front screen of the display, because this is easily scratched. Do not use aggressive solvents, but at most a slight moistening swab with distilled water or a damp piece of cloth or microfiber! Make sure that no moisture reaches the inside of the device!

Operate the touchscreen only with your finger or with a suitable pen (soft, round tip), never with hard, sharp-edged objects!

The device possesses a high-level headphone jack. Never set the volume too high!

### 3. First steps

After you have received the device and carefully read the operator manual (especially the above safety precautions!), you can now put it into operation.

#### 3.1 Unpacking and first-time operation

Please unpack the device carefully and place it on a hard, flat surface. If you have just moved the device from a cooler to a warmer environment, please leave it switched off for a while to avoid any possible condensation moisture. By placing a hand on the top cover, you may decide whether the unit has reached approximately ambient temperature.

At least the following accessories are always included with the device:

- WiFi antenna ("stub antenna" SMA)
- GPS antenna ("GPS mouse" with long cable and SMA connector)
- Touch pen for scratch-free operation of the display touch screen

Now connect the power supply cable. The coaxial DC plug ("hollow pin" for 2.5 mm pin) must be plugged into the DC socket of the RDR52 (see 5.1 Controls and connectors). The **positive pole** must be on the **middle connection**. The power supply (power pack or accumulator or similar) must be able to supply at least the current specified in the specifications. Inadequate performance of the power supply is noticeable when attempting to switch it on as the device will be switching off and on again quickly ("rattling" can be heard in the device and normal operation is not possible).

The quality of the power supply has a major impact on the reception performance of the RDR52. Interference, e.g. from insufficiently suppressed switching power supplies or unfavorable grounding conditions (the negative pole in the device is connected to ground) can significantly reduce the potential performance of the RDR52!

You can now switch on the RDR52 using the push button on the front. The current software version of the display appears immediately. After a few seconds, the user interface appears and the device is ready for use. The device setting always corresponds to the status when it was last switched off (but dialogs are always closed).

When you first switch it on, usually manufacturer-chosen settings from the final test of the device are currently chosen, e.g. the reception of an AM station on long, medium or short wave or an FM station in the FM range. This manufacturer setting can be used as a starting point for your own device configurations. However, the RDR52 can also be reset to a basic setting ("Factory setting / Defaults" in the System dialog) and reconfigured from this setting, which is always the same.

#### 3.2 General information on operation

In order to be able to receive any signal with the RDR52, you need an antenna. It has to be connected to the appropriate BNC input socket (0 – 71 MHz or 87 – 156 MHz / DAB). Avoid mechanical stress to the socket! Note the **maximum input level** of the RDR52! Please always use an antenna with a standard 50 ohm connection impedance. Antennas mounted / grounded directly on the housing (e.g. telescopic antenna with BNC base) do not work optimally due to the influence of the digital units of the RDR52, especially the display integrated in the housing. The RDR52 achieves full reception performance only by connecting a (possibly galvanically isolated) remote antenna via a 50 ohm cable.

To monitor the received signal or to constantly listen to the stations either the built-in speakers can be used, or a headphone can be connected (3.5 mm jack). The received signals are shown in the spectrum display on the display.

*Note:* If the device is not in delivery state or factory settings (for example because you received it from another owner), settings may be present that prevent audio output and / or spectrum display. Then reset the RDR52 to factory settings (see section Dialogs → System).

If you want to use the GPS correction option, connect the GPS antenna to the associated socket and place the antenna in a location with good reception (e.g. the window). A check is possible via the GPS dialog (wait a few minutes until the receiver can receive satellites).

You can now adjust the RDR52 to your liking. All set values are selected by tapping on them (they will then be highlighted). Use the right tuning knob, the touchscreen "swipe" function or the direct decimal frequency

entry to tune to a station and use the left rotary knob or the touch sliders on the display to adjust the volume. All other setting options are described in detail in Chapter 5 "Operation".

## 4. Device description

### 4.1 Mechanics

The RDR52 is housed in an extruded aluminum profile case with bolted front and rear panels. The housing is powder-coated, the front and rear panels are anodized or powder-coated. Before coating, all parts are conductively chromated. The contact surfaces of the front panel, rear panel and housing are uncoated in order to achieve maximum shielding effect of the housing (large-area conductive connection of all parts). Uncoated parts are partly visible with a bright shine, this does not represent a defect in the housing coating.

The back plate on the rear of the device carries all RF sockets and the power supply socket. All sockets are well conductively connected to the circuit and housing ground, as well as the negative pole of the power supply. If the RDR52 is to be specially grounded (e.g. when discovering cabling with the lowest possible interference), the grounding should be carried out at the RX input socket 0 – 71 MHz (grounding of the coaxial cable connected there). A good grounding is also possible at the GPS or WiFi socket, e.g. using a 6 mm cable lug and a suitable nut for SMA sockets.

The front panel primarily carries the controls (rotary knobs for volume and tuning), the display and the speakers. The display has a pressure-sensitive touchscreen. It is spring mounted in the front panel. Pressing the touchscreen too hard can push the display into the case, creating a gap between the display and the front panel. Dirt or moisture could then penetrate the housing, which can render the touchscreen or even the entire device unusable. This is to be avoided at all costs!

The RDR52's main circuit board is located within. It also contains the 3.5mm jack sockets for headphones, microphone and morse key accessible through holes in the front panel, as well as the on/off switch. There are 2 expansion slots for special modules on the mainboard. These can be installed or removed after the device has been dismantled. This is only possible at the manufacturer / allowed during the warranty period. If the modules require connectivity to the outside world (inputs / outputs for signals), the necessary sockets are also screwed onto the rear panel and are accessible there.

### 4.2 Electronics

The mainboard and possibly one or two extension boards ("modules") carry all the electronic units of the RDR52. Expansion boards are pluggable to the motherboard via connectors specially designed for high-frequency analog and digital signals. All connection sockets are soldered directly to the main or expansion board, as is the rotary knob for tuning. The rotary knob for the volume setting, the loudspeakers and the display are connected to the main circuit board via detachable plug connections and cables.

The core of the RDR52's electronics consists of a highly integrated FPGA (Field Programmable Gate Array). This circuit is programmed by special software (called "Configuration") to generate all the modules for basic signal processing. Those are:

- 32 bit microcontroller with 2 cores (user guidance / device control and display processor with hardware accelerator)
- Downconverter with filter for the ADC data
- Broadband Spectrum Analyzer (only with "Broadband Spectrum" option)
- Narrow Band Spectrum Generation and Processing for Audio and Video (SBSP)
- Broadband FM demodulator with RDS decoder
- Time-based demodulators with filters (some only with "High-End FM" option)
- Audio generation from spectrum data (back transformation into audible signal)
- Various modules such as interfaces (memory, I<sup>2</sup>C, I<sup>2</sup>S, graphics ...) and clock generation.

Thus, the FPGA realizes all receiver functions by hardware. There is no processor, DSP or similar that performs signal processing. Likewise, no memory typical for computer technology (HDD, SSD, DDR3/4-RAM, etc.). The softcore microcontroller for operation and graphics works with a proprietary (manufacturer-specific) real-time operating system (no Linux, Windows or similar). Therefore, the RDR52 cannot store or run SDR software or other computer programs.

In addition to the FPGA, there are several other modules. The most important are:

- Analog signal processing (HF preamplifier and filter, switcher, attenuator)
- Analog-to-digital converter (ADC, 2x 16 bit)
- Low-noise main clock oscillator



- Digital-to-analog converter (DAC, 2x 24 bit) for audio output, ADC for microphone signal
- 4 to 16 Gbit flash memory for recorder function
- 2 pieces of LPDDR4 memory circuits (SBSP and video)
- Various DC/DC converters and linear regulators for display lighting and operating voltages
- WiFi controller with memory and analog circuits
- GPS module

In the case of expansions, the following modules are added to the corresponding expansion boards:

- Microprocessor for transmitter control (SW transmitter C3)
- PWM amplifier for transmission power (SW transmitter C3)
- Digital HF signal generator (SW transmitter C3)
- GaN-FET transmitter amplifier Class E/F (SW transmitter C3)
- Preamp and filter for FM and extended 2m band (FM Module C2)
- DAB+ receiver module (FM module C2)
- 2x 14 bit HF-DAC 667 MHz plus amplifier and filter (Exciter C4)
- Stereo HiFi DAC 24 bit / 104 dB SNR (Line Out C5)
- Digital tuner (plus exciter) 70MHz - 6GHz (Wideband (T)RX C6)

### 4.3 Firmware

The firmware (internal operating software) of the RDR52 is programmed into a non-volatile memory (Flash). Each time the device is switched on, the firmware is loaded into the FPGA and configures it according to the necessary units. In addition, the configuration contains the software of the softcore microcontroller for the user guidance and the graphics of the device.

This software essentially determines the device functions, e.g. what can be seen on the display, what settings are available, etc. Because it is stored together with the FPGA configuration (which defines the capabilities of the hardware), both can be updated together, allowing for new device functions. The flashing of new firmware (FPGA configuration plus controller software) is accomplished via a Wi-Fi connection ("WiFi") to a personal computer. In addition to the WiFi capability, the PC must have a Windows operating system. A loader exists for this operating system, with which (among other things) new firmware can be flashed into the device.

The RDR52 utilizes an independent controller for its WiFi and Bluetooth functionality. It possesses its own memory and own software. This software can be re-downloaded from a PC, too (LAN driver).

The following description applies to configurations from version V212 (device "RDR52") or V05 (WLAN) driver).

## 5. Operation

### 5.1 Controls and connectors

The following operating and connection options are available for the RDR52.



Front of the RDR52

Below display from left to right:

#### - Volume control LS / HP.

Turning the knob affects the volume of the built-in speakers or headphones. Switching is done by briefly pressing the knob. If the loudspeakers are set to "Off" in the Setup dialog, the button in the "LSP" position affects the "AF Level %" parameter in the System dialog (adjustment in the level of the line-out output of a C5 module). The touch sliders at the bottom of the display work in parallel with the knob. They always show the current volume of headphones and speakers. A red colored button of a display control indicates that the tuning knob is currently affecting this control.

#### - Headphones (3.5mm stereo jack)

A stereo headphone can be connected here.

#### - Morse key (3.5 mm stereo jack)

A Morse key can be connected here or a definable signal can be wired ("TX" dialog).

#### - Microphone (3.5 mm stereo jack)

A mono microphone can be connected here, with the plug tip carrying the signal. A 5 V bias with approx. 7 kOhm internal resistance can be connected to the signal connection to feed electret microphones ("Microphone" dialog). A definable signal can be connected to the connector ring ("Ring").

The morse and microphone jacks allow the input and output of various signals, respectively. Which signals are switched to which connection is defined in the "TX" dialog. All signals are 2.5 V CMOS level with max. 1 mA load capacity when switched as output. The ring connection of the microphone jack has a pull-up resistance of approx. 5.3 kOhm, ring and tip of the morse key socket of approx. 2.8 kOhm. Contacts or open collector outputs can be connected to ground (GND connection of the jacks / plugs) here.

**- On / off button (illuminated in blue).**

As soon as the supply voltage is connected to the DC socket on the back of the device, this button lights up. When pressed, the RDR52 is turned on. When the button is not in the pressed-state, it is switched off.

**- "Tune" knob.**

This is the main tuning knob for setting up the device. A set value selected as active on the display is changed by turning the knob: Turning it to the left (counterclockwise) decreases the selected value, turning it to the right (clockwise) increases it.

**- Loudspeaker next to the display:**

The built-in loudspeakers output the received and demodulated signal. Quasi-spatial (-stereo) output is possible in many operating modes, with FM-W real FM stereo.

*Note:* Due to the small distance between the loudspeakers, the basic stereo width is only sufficient for short distances between the listener and the device. For longer (common) distances, FM stereo baseline width can be increased up to 200% (double) to achieve good stereo sound.

**- Display:**

The display has WVGA resolution of 800 x 480 pixels. It has a touch-sensitive surface ("touchscreen"). All adjustments are triggered by selecting ("tapping") a displayed graphic symbol. The selected value can then be changed by turning the Tune knob. In addition, most adjustment values can be changed by swiping the display of the spectrogram (to the right → increase value, to the left → decrease value). This function can be activated in the Setup dialog.

The selection or activation of a value for inputs is signaled by highlighting the otherwise dark background of the value. In dialogs, the coloring is reversed: Not selected = light background, selected = dark background.



**Rear of the RDR52**

*Left to right:*

**- "+12 V" socket**

Connect the power supply here. The socket is a standard DC (hollow pin) socket with a 2.5 mm pin (positive pole). The RDR52 is operational within the voltage range specified in the specifications. In particular, avoid overvoltage or wrong polarity. The connection is briefly (a few seconds) protected against overvoltage and wrong polarity up to 30 V. **Prolonged overvoltage / incorrect polarity can lead to a defect of the device!** Correctly connected voltage is indicated by illumination of the power button on the front panel.

### - SMA socket "WiFi"

Screw the supplied WiFi antenna (approx. 10 cm long rod antenna) here. After switching on the 2.4 GHz transceiver ("WiFi" dialog), the RDR52 can establish Bluetooth and WiFi connections.

### - SMA socket "GPS"

Screw the cable of the supplied GPS antenna (oval black housing) here. After detecting satellites and evaluating the data, the RDR52 can display the geographical position and the world time (UTC) ("GPS" dialog) and carry out an automatic calibration of the internal main oscillator ("System" dialog).

### - BNC socket "0 – 71 MHz"

Connection of the receiving antenna for the ranges 0 – 30 MHz and 50 – 71 MHz.

Depending on how the RDR52 is equipped with additional modules (hardware), there may be additional connections on the rear.



### - BNC socket "87 - 156 MHz / DAB"

If a module C2 ("FM module") is installed, a receiving antenna for the ranges 87 - 110 MHz (FM), 130 - 156 MHz (2 m) and 174 - 240 MHz (DAB) is connected here.

### - BNC socket left of +12V power supply

If a C4 module (broadband exciter) is installed, the exciter output is available here.



### - 3.5 mm jack socket on the top left of +12 V power supply

If a module C5 (HiFi Audio DAC) is installed, the stereo line-out output is available here.

## 5.2 Set values

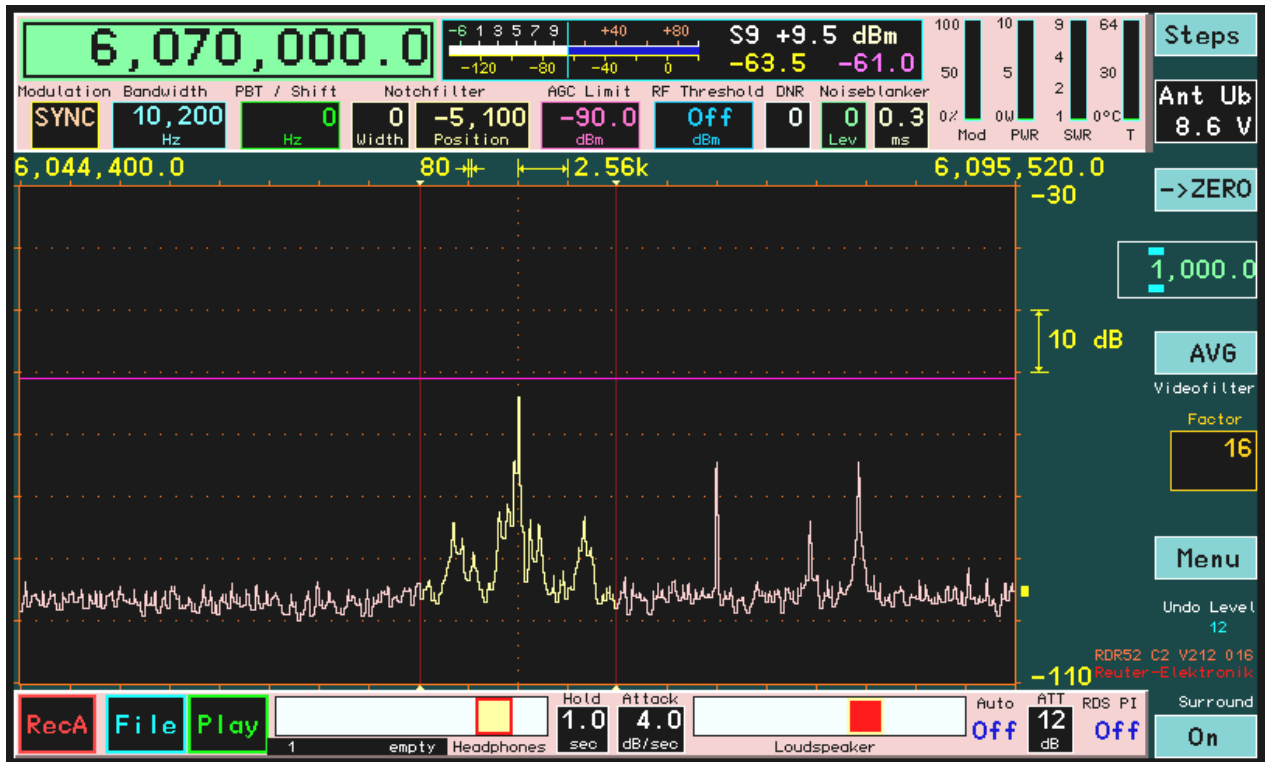

**User interface of the RDR52 with set values**

The RDR52 is operated by selecting a set value by tapping it on the display (touch screen) and adjusting it by turning the main "Tune" knob. Furthermore, virtual buttons are provided for switching functions or activation of further input options.

A set value is displayed with a dark background and colored writing when it is inactive. If it is activated by tapping it, it is displayed with a colored background and dark writing (e.g. the frequency in the image above). Only one set value can be active at any one time. Exception: The sliders for the volume are always active, regardless of the other set values.

The following is a description of the set values and buttons on the user interface (appearance and labeling may differ slightly depending on the firmware version).

### - Frequency (large at the top left)

Selecting the frequency display as the active input value (1x tap) allows the tuning of the reception frequency. Each locking step of the tuning knob changes the frequency by the value of the set step size. Direct entry via a virtual numeric keypad (Memory dialog) is possible.

The display of the frequency has a special function: When the maximum processable input level is exceeded, the box lights up red. Then switch on the attenuator (see "Setup" dialog) or / and reduce the input voltage at the antenna input!

Settings can be made with an accuracy of 0.5 Hz. There are different setting limits, depending on the selected filters (see description in "Setup" dialog). Direct entries are rounded to the possible maximum or minimum value. Rotation of the tuning knob at the region boundaries has no effect.

Double-tapping on the frequency display opens the "Memory" dialog (see there).

### - "Steps" tuning grid (virtual button at top right)

The step grid, in which the reception frequency can be adjusted, can be configured via the virtual "Steps" button. When tapping, the step size shown below (value in the white rectangle) becomes the active input point.

The step size can now be changed with the tuning knob. To simplify the setting, you can set the point at which it changes up or down. It is characterized by two light blue horizontal bars above and below the selected digit. These bars (and thus the lowest order active input point) can be moved to the left and right

by dragging on the touch screen.

You can return to the frequency by tapping on the "Steps" button (it is labeled with "Escape" if the step size adjustment is active = you leave this setting). From now on the frequency setting always adds or subtracts the new value to the frequency.

Quick selection of common step sizes is possible by double tapping on the inactive setting. To do this, the **frequency setting** must be active (tap, if not active). Tapping once activates the grid setting briefly. Tapping again while it is active displays a selection of different step sizes. Tapping a value closes the selection menu and returns to the frequency setting.

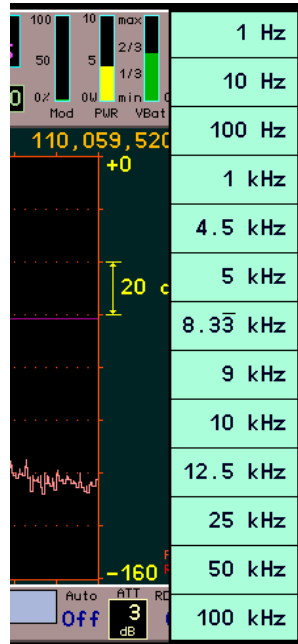

**Menu for selecting common frequency step sizes**

The increment of 8.33 kHz is "real"  $8 \frac{1}{3}$  kHz. This means that the periodic fraction  $\frac{1}{3}$  is taken into account, there is no truncation of 0.3333 ... Hz digits. In the case of continuous tuning, this would otherwise lead to the totaling up of the missing positions and thus to an increase in the tuning error.

*Note:* A step size broken down to  $\frac{1}{3}$  cannot normally be set by changing the "Steps" setting on the user interface. This can only be achieved by making a selection in the menu. However, after selecting 8.333 kHz, each digit of the step size can be changed individually. With this, for example, a step size of 333.3 Hz period or similar can be set. When changing the 0.1 Hz digit, however, only the setting 0 or 5 is possible! In this case, the consideration of the 3-period is lost (always "smooth" setting to 0.0 Hz or 0.5 Hz).

#### - Button "->ZERO"

The adjustment of frequencies and the corresponding steps can cause slightly offset settings. In this case, by tapping the "->ZERO" button, an update can be achieved as follows:

- Frequency values are always set to the next lowest integer multiple of the associated step size, unless a range limit conflicts.
- When adjusting the step size, all digits right from the selection bar are set to zero or it will be set to the lowest or highest possible value of the step size.

This function allows you to easily correct frequency values after changing the step size or automatic adjustment to the field boundaries.

Example (the "Hz" is not displayed):

Current frequency setting 1,124,550.0 (Hz), the corresponding current step size is set to 10.0 (Hz).

→ New setting of step size to 1.000 (Hz). If the frequency is now adjusted, it is always tuned in 1000 Hz steps, e.g. in clockwise rotation: 1,125,550.0 ... 1,126,550.0 ... 1,127,550.0 and so on.

However, your intention in choosing the step size was probably the desire to tune the frequency to rounded

thousands. You would now have to set such a "straight" frequency by direct input, would have to set it exactly before choosing the new step size, or again adjust the step size to initially 10 Hz (50 Hz, 150 Hz or 450 Hz would be more effective) and adjust it "smoothly".

This effort can be avoided by tapping the "->ZERO" button after adjusting the step size to 1,000 (Hz). The frequency is now automatically set to the next lower multiple of 1000 Hz, e.g. 1,124,000.0 (Hz).

The "zeroing out" of the lower digits also works with the frequency setting itself. It should be noted that it is always set to multiples of the currently valid grid value. If it is "crooked", the frequency is also set to a matching "crooked" value.

#### - Antenna control

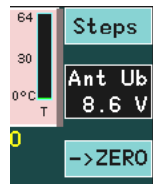

If the remote feeding / control of an antenna is switched on (see "Setup" dialog), this value allows the setting of the different modes.

#### - Modulation (operating mode)

The type of acoustic playback of the received signal ("mode") is determined by the demodulators. They generate the audible signal from the spectra of the received signal ("SYNC" to "CW"), or from the signal itself (all other demodulators) according to the desired type of modulation. The following options are available.

*Spectrum-based (pink indicator):*

- SYNC: Automatic detection of an amplitude-modulated double-sideband signal with carrier (A3E, AM radio stations). The demodulator continuously determines the spectral line with the highest level within the audible range and interprets it as a carrier. The associated frequency is defined as the carrier frequency of the entire signal within the passband display; all other signals are viewed as sidebands and processed accordingly. Once a carrier is detected it is approximately 1.5 second "held", even if other signals reach temporarily higher values. Carrier frequency changes will be immediately "rejected" and resynchronized.

The demodulator "SYNC" also allows single-sideband demodulation of an A3E signal. When activated, the caption of the virtual button "->ZERO" changes to "SyncSB". Thus, the selection of the desired sideband is now possible: SLSB (left / lower side of the spectrum), SUSB (right / upper side) or SYNC (both sidebands). The values for bandwidth and shift are set accordingly. It should be noted that the carrier of the AM signal must always be present in the yellow (demodulated) listening area. Further manual adjustment of bandwidth and / or shift such that the carrier is no longer within the hearing range prevents demodulation.

- DSB: Double sideband signal with no carrier evaluation (A3E).  
The channel processes all signals such as the carrier would be exactly on the center line of the spectrum and generates the audio signals corresponding to the distance and level of the spectral lines from the center line.
- LSB: "Lower Side Band", lower sideband of a SSB signal (J3E):  
The demodulator generates audio signals corresponding to the distance and level of the spectral lines from the center of the spectrogram to the left boundary line of the bandwidth.
- USB: "Upper Side Band", upper sideband of a SSB signal (J3E):  
The demodulator generates audio signals according to the distance and level of the spectral lines from the center of the spectrogram to the right bandwidth limit line.
- EUSB: This is an extension of the USB demodulator (Extended Upper Side Band). An imaginary carrier frequency is assumed at the left side of the spectrum and not in the middle. The entire spectrum width is then available to the right (with appropriate adjustment of the frequency resolution) and not only the right half. The maximum bandwidth limit + shift is set to 15 kHz audio frequency.

The importance of this demodulator is particularly given at very low frequencies (ELF) such as lightning observations, "Whistler" reception, submarine or radio observations of the Earth's magnetosphere. As a result, a frequency setting down to 0 Hz is possible. This mode produces a reproduction of the received EM waves with exactly the same audio frequency without any conversion or shift. As soon as the receive frequency is increased (the left edge spectrum larger than 0 Hz), a corresponding frequency conversion

will happen so that the reception frequency at the left edge of the spectrum resembles an audio frequency of 0 Hz.

- SBCW: "Single Side Band + CW", automatic selection of the sidebands at 10 MHz:  
The demodulator generates audio signals corresponding to the distance and level of the spectral lines from the center of the spectrum to the left (receive frequency below 10 MHz) or to the right (receive frequency greater than or equal to 10 MHz) boundary line of the bandwidth. At the same time when operating as a SSB-transmitter (with expansion module) the emission of a keyed CW signal within the sideband is possible.
- CW: "Continuous Wave" Morse (A1A):  
The demodulator produces an audio tone with the level of the spectral line directly on the spectrogram's centerline and a frequency that is adjustable via the "Shift" value (now "CW tone" / "CW-Pitch").

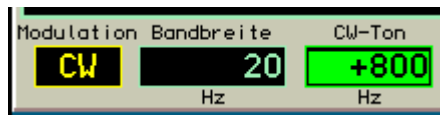

**For CW, the set value changes from "Shift" to "CW Pitch."**

*Time-based (yellow indicator):*

- FM-N: Narrow Frequency Modulation (F3E):  
The demodulator directly generates a frequency-demodulated signal from the ADC's signal with a maximum bandwidth of 20 kHz. Suitable for FM signals with a deviation up to  $\pm 7$  kHz.
- FM-W: Wide Frequency Modulation, with optional stereo multiplex decoder (F3H):  
The demodulator directly generates a frequency-demodulated signal from the ADC's signal with a maximum bandwidth of 300 kHz. Suitable for FM signals with a deviation up to  $\pm 80$  kHz. With this a stereo decoder for FM broadcast signals can be activated via the "Surround" button (labeled "Stereo" in FM-W).

*Note:* The stereo decoder generates the left and right audio channel from the spectrum of the demodulated FM (MPX) signal. Therefore, in stereo no view of the RF signal in the narrow band spectrogram is possible. Instead, the MPX signal is presented in the spectrum. If the RDR52 is fitted with the broadband spectrum analyzer (optional equipment), the RF spectrum is also displayed when setting a resolution greater than 320 Hz / line.

- LSBQ / USBQ / DSBQ: Single sideband (LSB and USB) as well as double sideband (DSB without carrier).

Demodulators that are modeled after the operation of analog technology. Just like AM-E, they provide higher audio signal quality over their spectrum-based counterparts. However, they offer a lower functionality of the setting options such as lower selectivity, no notch filter and no DNR.

- DIGI: Special USB demodulator for receiving / transmitting RTTY, PSK, Weatherfax, SSTV and similar. DIGI is a counterpart to CW and also possesses an adjustable signal pitch. This allows you to set the signal tones of the "Digi modes" to the frequencies required by the PC software. The pitch can also be set to negative values. This corresponds to a permutation of the sidebands (LSB receiving) and thus an inversion of the pitch or the bits in the decoding.
- AM-E: Double-sideband AM with carrier (A3E):  
The demodulator generates an audio signal directly from the signal from the ADC, whose amplitude curve corresponds to the shape of the envelope (peak amplitude, magnitude). With good reception, it allows a demodulation as in old tube / transistor radios with similar sound.

The spectrum-based demodulators are characterized by a unique mode of operation. The data generated by the time-frequency transformation (spectral lines, "bins") are used directly to make the received signal audible. If you set the resolution in the spectrum diagram to the same value with which the audio signals are generated (see "Setup" dialog), then you see exactly what you hear (yellow listening area). Of course, no video filtering (average, Min / Max) is used for the audio generation and there is no limitation by the display frame rate. The result is an extremely sharp filter curve (very high selectivity), fine adjustability (selection of the listening area by selecting the spectral lines) and additional possible signal processing (effective DNR, NB, etc.).

Compared to their spectrum-based counterparts, the time-based demodulators are distinguished above all



by lower harmonic distortion, constant envelope delay in the pass band and significantly lower signal delay during reception (only a few ms compared to about 100 ms for SBSP). This makes them especially suitable for signal output to the sound card of a PC. The output is sent to the two channels of the headphone jack as a separate I and Q signal. This enables the use of common SDR software for further processing. Especially in DSBQ mode with 12 kHz bandwidth this corresponds to the output of simple direct mixing receivers (but higher signal quality). The RDR52 can thus be used as a high-quality SDR.

These demodulators can also be used to receive normal SSB and CW signals. The IQ output to the headset then generates a "quasi-spatial" listening experience. The I and Q signals are assigned to the right and left headphones so that a location of the frequency position is possible. A signal in LSB is perceived as being on the left, a signal in USB as being on the right.

Double tapping on the display (or just once on an active display) opens a menu for quick selection of possible demodulators:



The setting of the demodulator to receive the desired transmission is an essential basic setting of the RDR52. For example, amateur radio in the SW range is operated almost exclusively in SSB, broadcasting in the LMK ranges in AM and in the FM range with FM-W. Accordingly, when switching the demodulator, other values such as bandwidth, control parameters or spectrum settings usually have to be changed as well.

In order not to have to change many other parameters manually with each demodulator switch, these are internally available several times. If the demodulator setting changes, the appropriate one is selected from this set of parameters and automatically loaded into the set values. Example:

With SYNC, the bandwidth was set to 10 kHz. After switching to LSB, the bandwidth was set to 3 kHz. If you now switch back to SYNC, the bandwidth of 10 kHz that applies there is automatically activated again. It can now be changed here as required. If you switch back to LSB, the applicable (last selected for this demodulator) bandwidth of 3 kHz is set, regardless of the changes in SYNC mode.

This dependency of different settings on the demodulator applies to most of the parameters that have something to do directly with the reception setting (bandwidth, shift, notch, ...) or the spectrum view (position and resolution of the spectrum in the diagram). The demodulator cannot be used to change basic device settings such as volume or display brightness.

**Caution!** When storing the device settings in a memory slot, the complete set of all individual set values is always saved. If the device settings are loaded completely from a memory slot (see the "Memory" dialog), all settings including the "hidden" ones (other than those assigned to the currently active demodulator) are also loaded. However, if you only partially load, only a part of these hidden settings will be loaded and a part will remain as it was last set before loading! If the demodulator is switched over when loading from the memory, the other values depend on whether loading is complete or only partial.

The other parameters are not saved for each individual demodulator, but in groups of demodulators:

- 1.: SYNC
- 2.: DSB, LSB, USB, EUSB, SBCW, CW
- 3.: FM-W
- 4.: FM-N, DSBQ, LSBQ, USBQ, DIGI, AM-E

For the notch filter, DNR and NB (see below), demodulator dependent storage is as follows:

- 1.: SYNC, DSB, CW
- 2.: LSB, SBCW when frequency < 10 MHz
- 3.: USB, EUSB, SBCW if frequency >= 10 MHz

There is no separate differentiation of the parameters within a group. For example, when switching between LSB and USB, the currently available bandwidth always remains active. Only when switching to SYNC or FM-W or FM-N (DSBQ, LSBQ, USBQ, DIGI, AM-E), the bandwidth valid in this group (set last time) is activated.

## - Bandwidth (Bandwidth) and Shift (PBT)

Bandwidth and shift can be adjusted in increments and limits that depend on the particular demodulator and the selected audio resolution (Setup). With the spectrum-based demodulators, fine-tuned adjustment is possible over a wide range (filtering is "only" done by selecting spectral lines, there are no ordinary band filters). The time-based demodulators require a special band filter for each bandwidth and are therefore limited in the number of filter options.

If a time-based demodulator is selected, double tapping on the bandwidth setting will open a menu for selecting the possible values (example AM-E):

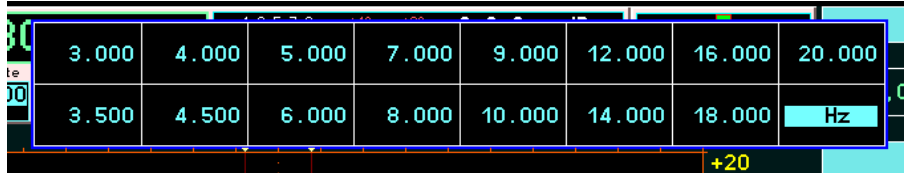

*Note:* Depending on the modulation type, bandwidth and shift can only be adjusted as far as the selected sideband position permits. For example, no adjustment is possible for LSB where signals to the right of the center line of the spectrogram (in USB, the wrong sideband) could become audible.

## - Notch filter

The notch filter is used to filter-out one narrow band signal within the passband for the suppression of interfering signals. The width of the filter and its position can be adjusted relative to the receive frequency.

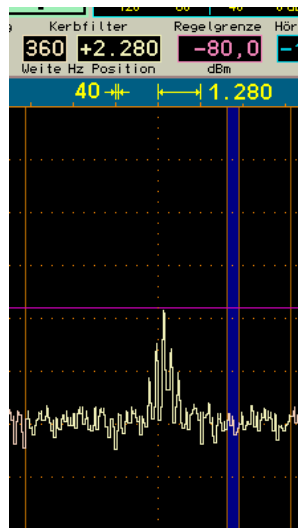

**Settings and display of the notch filter.**

The relative position is converted into the absolute frequency in the passband and then stored. It remains when adjusting the receiver frequency, even if the filter area (relative position) falls outside the passband. The display of the position is set to the maximum positive or negative value according to the bandwidth. Due to storage of the absolute frequency, the setting can be automatically restored if the receiver is tuned so that the notch filter falls in the audible range again ("semi automatic" filter, tracking of relative position).

*Note:* The filtered out (and therefore inaudible) area of the notch filter is displayed in blue when the lower blue, horizontal marker line (hearing threshold) is switched on (values above -140 dBm or the lower limit of the spectrum).

The notch filter in (spectrum-based modes only) can be switched to full automatic mode (and back to semi-automatic mode) by tapping on the active notch position indicator. The message "Aut" followed by a set value appears. This value determines the hold time (in tenths of a second) of the filter on a found interference signal. This changes the "agility" of the filter when searching for interfering signals. Short hold time = high agility results in a quick start of recognized interference carriers, but also the fast misinterpretation e.g. of AM modulation signals as interferers. Long hold time = low agility reduces misinterpretations, but increases the time it takes to find interferers.

For FM stereo, the width setting is used to set the stereo base width. With values above 100% (normal setting), the stereo effect of the built-in speakers can be significantly increased.

## - Control limit (AGC Limit) and hearing threshold (RF Threshold)

When the spectrum is displayed, two horizontal marker lines appear in the display. Their content refers the values of the "RF Gain" (manual gain control) or "AGC Limit" (automatic gain control), and "RF Threshold".



### Setting and display of the lowest and highest audible level.

The lower marker (blue) indicates the signal threshold above which a signal is audible. All signals whose level is less are inaudible.

The upper marker (purple) indicates the signal level that produces the maximum level of the audio signal. Signals above this marker are limited (or distorted). Internally, the RDR52 operates with a 6 dB safety margin ("headroom"), so that in case of low clipping distortion does not occur immediately.

The marker can be moved by selecting its value. Direct input via the virtual numeric keypad is also possible.

Since the upper marker can be seen as the RF gain of the receiver (compared to analog receivers), it can be adjusted by manual operation, or as an Automatic Gain Control threshold. The mode is selectable in the Setup dialog. In automatic mode, the hold time used to set the marker position lower and the speed of the marker shifting downwards after the holding time (compares to "Decay" in an analog receiver) can be varied within wide limits. The movement upwards (= "Attack" / "Desensitization") always happens immediately upon detection of a higher level and the associated signals are processed only after the shift. The automatic mode thus prevents clipping.

**Caution!** The automatic control only responds to signals that are selected in the spectrum (shown in yellow)! Signals shown in red, (that is outside the passband or within the notch filter) will not affect the marker position. However, since these signals are not processed, they can not cause clipping.

When manual control is selected the top marker describes by how many dBs a received signal on the marker line has to be amplified to reach 0 dB (full scale) of the audio signal. This "0 dB" audio level relation to the 0 dBm RF level is not an absolute value in dBm or dB $\mu$ V because the audio signal is not generated in a well-defined impedance environment and amounts to far more than 1 mW (0 dB audio = about 5 Vpp at headphone and 10 Vpp at speaker output). The gain value of the upper marker is to be considered a relative value.

In automatic mode, this marker is moved by the RDR52 itself. It automates the process of gain regulation. This allows for close monitoring of their effect and possibly an adjustment of the control parameters. The setting for the upper marker is a control limit (maximum gain) to prevent excessive gain. This limit can be set in dBm / dB $\mu$ V as it directly relates to the received signal.

*Note:* The control limit should never be set too low, but always at least 10 – 20 dB above the smallest received signal (noise). Otherwise the RDR52 increases the amplification until the noise is reproduced at full volume!

When using the FM demodulators, the markers work differently:

- FM-N: The signal for the narrow FM demodulator is used under the following scheme:

The lower marker receives the sum of all the audible signal spectral lines. It must be placed clearly above

the visible lines for its function. The upper marker determines gain / control limit. However, since FM is an amplitude suppression modulation scheme, the gain is not critical to the demodulation process. Only when there is too little gain (near the top marker, signal is very small) will the demodulation be aborted. The top marker can thus be used as a "noise gate" or "squelch". Set it so that unmodulated noise is not demodulated and the demodulation starts only at useful signals.

- FM-W: The signal for the wide FM demodulator is used prior to gain regulation.

The FM-W demodulator has a special algorithm for very high amplitude suppression and therefore requires no control. The lower marker can be used for a "Mute" or "Squelch" function. The effect depends on whether the stereo decoder is on or off.

- Mono: There is an RF level dependent muting corresponding to the selected level for the hearing threshold.

- Stereo: There is a noise-dependent muting. For this, the signal-to-noise ratio of the pilot signal in the MPX signal is selectively measured. If it falls below about 24 dB, it will be muted. If it rises above about 30 dB, it will be switched to loud. The hearing threshold setting has only one on / off function (all values above "Off" turn the function on).

The muting of FM-W does not completely suppress the signal. It is only lowered by about 42 dB. Even when the receiver is muted, it can so be determined if reception is available.

**Caution!** Do not increase the volume so far that the muted signal is audible! As soon as the receiver engages, an accordingly high volume is available! This can lead to hearing damage when using headphones or connecting powerful amplifiers!

#### - DNR

"DNR" stands for "Dynamic Noise Reduction", the noise reduction system of the RDR52.



A setting other than zero sets various algorithms with different levels of efficiency in operation. Values up to approx. 5 can be used for high-quality audio playback. At higher values, artifacts are noticeable depending on the signal content. Values of 10 or more are only usable for CW.

**Caution!** The setting of the noise reduction system has a major impact on audio quality! In addition to the planned reduction of noise the quality of usable signals is also affected. Only set the noise reduction system to values above 0 if necessary and try to find a setting that best suits your needs.

#### - Noise blanker

In addition to the dynamic noise reduction system "DNR" the "NB" (Noise Blanker) is available for impulse noise reduction. This system recognizes signal glitches (like discharge, ignition interferences, voltage spikes caused by switching, ...) by their typical fast signal rise and their broadband frequency spectra respond.



The noise blanker benefits from the spectrum-based operation of RDR52. The signal evaluation takes place in the entire simultaneously received spectral range with approximately 164 kHz width. If a noise pulse is detected, the RDR52 is muted for a short period.

The noise blanker has two settings:

- Level: This value with a variable 0 to 15 defines the threshold level and the signal slew rate at which a signal is to be classified as a glitch.
- ms: Duration of mute.

The level value is a level setting of the noise blanker sensitivity. It displays in red during blanking. The higher the score, the more sensitive the blanker classifies signals as a nuisance. "0" is no blanking and at "15" already increased noise or a weak signal with a wideband modulation is defined as a disturbance.

The "ms" value defines the blanking duration in milliseconds. It is limited to 9.9. If another fault is detected within this time, a new blanking takes place immediately ("retriggerable" noise blanker).

Follow these steps to set the best functionality as follows:

- Place a temporary blanking setting: Usual disturbances last approx. 0.3 - 0.5 ms.
- Increase the level value from 0 to such an extent that the instantaneous received signal triggers the noise blanker. You can recognize this by the red illuminated digits of the level value when the value is selected (for better recognition, the black background illuminates red when the value is not selected) and the audible blanking signals ("machine noise" for quickly following blankings).
- Now reduce the level value by a few steps, so that an undisturbed useful signal no longer triggers blanking.

Depending on the type and strength of impulse noise the duration may be adjusted. It should be as short as possible to just bypass the glitch. The level value may need to be changed slightly depending on the received signal, because of the many simultaneous signals in the total range of 164 kHz (like tuning the receiver to the middle of a heavily occupied broadcast band) can cause unwanted triggering of the blanker.

The noise blanker also protects the system from interference signals. If the blanking time is set correctly, after the glitch the full receiver sensitivity is immediately available again .

The FM demodulators cannot generate blanking signals. Naturally, interference in FM mode has little effect on the signal quality. By using the system as an FM squelch unwanted noise can cause an increase in the squelch sensitivity. In this case use the AGC manual control or the lower marker ("threshold") for reducing audio noise.

#### - Spectrum display width

The central display object of the display is the representation of the spectrum of the received signals in a selectable frequency range. The RDR52 transfers a 163.84 kHz wide frequency band from the time domain into the frequency domain thus generating the spectra.

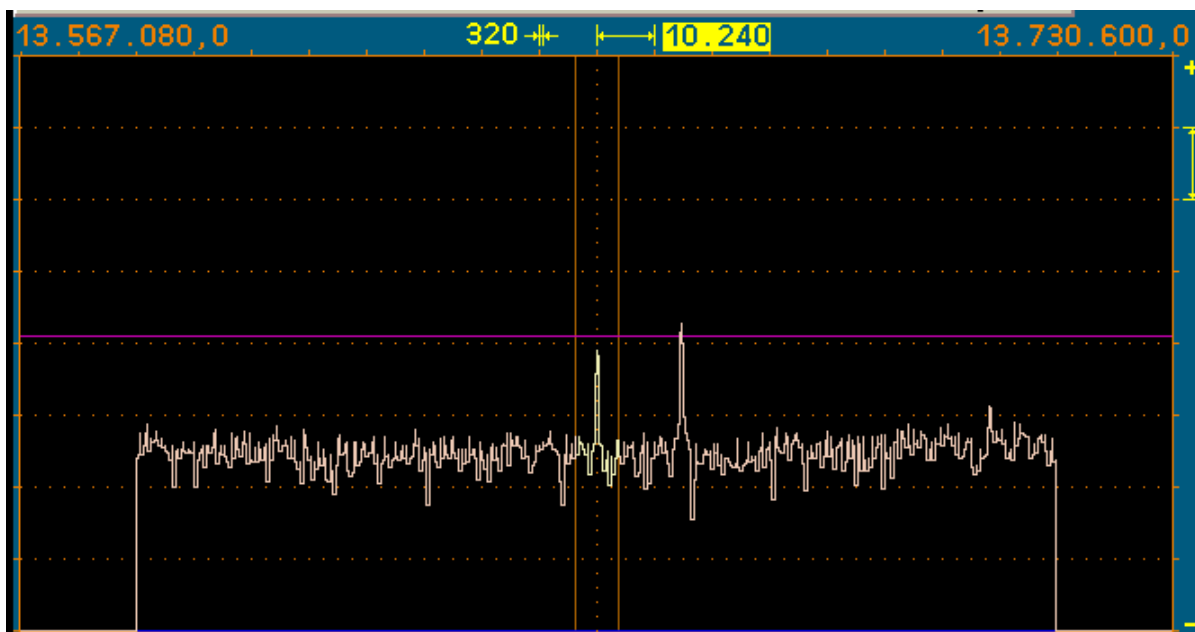

Setting the constantly visible width of the spectrum is accomplished by tapping the set value for the width of a spectral line or for the horizontal subunits, in the example shown above 320 (Hz) or 10,240 (Hz).

*"Broadband spectrum" optional equipment only:* 2 independently adjustable resolutions are always kept ready internally. You can switch between both with a tip on the active resolution setting (double-tip if not active yet). If the smaller or the same viewing width is selected compared to the alternative setting, the left value is highlighted (Hz/line), for the larger width the right value (Hz/scale part). As an example, this can be used with FM-W to quickly switch between MPX and RF view.

On the WVGA display 20 sub-units of each 32 lines (pixels) are available. Accordingly, this represents the overall width of the display. The frequencies of the first and last line are shown on the top left and right of

the spectrogram. The reception frequency usually always refers to the center of the spectrogram. The receiving frequency is shifted from the center only if the spectrum has to be limited in the case of extreme display widths, so that the largest possible spectral range can be displayed (see below under "Broadband Spectrum").

The visible width can be set to a maximum of the width of the spectrum-based DSP (SBSP, approx. 164 kHz) (see picture above). In this case the frequencies represent the left and the right side of the spectrum (only 512 lines wide). Any reduction in the width range is done by bisecting the current width. The minimum width is given by the minimum possible width of the spectral lines (= highest possible resolution) of the RDR52 of 10 Hz.

With existing broadband spectrum analyzer (optional), the viewing width can be increased beyond the SBSP range. Again, a change occurs when doubling / halving the width. A maximum of around 54.2 MHz can be displayed simultaneously. However, such a large area is limited to the respective receivable area by different prefilters.



**Broadband spectrum for displaying very large frequency ranges**

Within a spectral line, the amplitude attenuation is less than 0.2 dB. The line width of 0.2 dB corresponds to the distance between the vertical display lines. Thus, despite frequency discretion, no signal can remain "invisible". If a signal is exactly "between" 2 lines, it is shown as two lines of equal size and with a maximum of 0.2 dB attenuation. There is almost no "picket fence effect" or similar artifacts as with the usual FFT.

Outside of a spectral line, the attenuation increases rapidly and reaches 130 dB at the third line left and right from the selected frequency. This attenuation is maintained across all lines, there are no spurious resonances ("leakage") or similar artifacts of the FFT.

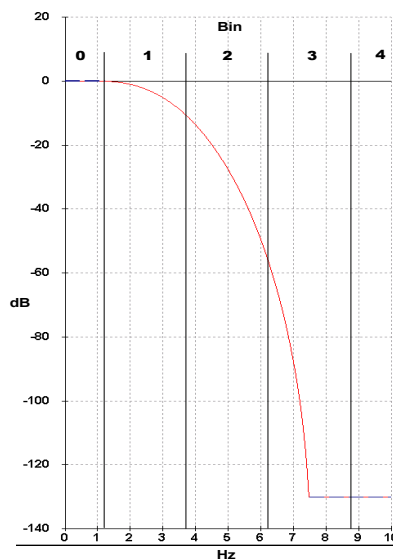

**Filter curve of a spectral line width of 2.5 Hz**

The lines are always drawn by the graphics controller of the display in such a way that their visible height corresponds exactly to the value of the associated spectral line. No sloping lines are drawn (no estimated intermediate values as an undefined "level").

The display speed of the spectrum is directly dependent on the selected resolution. The RDR52 calculates the spectra using a time sequence corresponding to 4 times the frequency resolution (4x over sampling). There is no frame rate limitation related to the resolution by principle (as Fourier transform has), just hardware speed and memory size limits the achievable over sampling factor.

Example:

Resolution 10 (Hz) = 320 Hz / sub-unit spectrum display frame rate = 40 Hz (images / s = frame rate). Switching to 20 Hz results in 80 frames/s, etc. However, the maximum possible display frequency is only equal to the display's frame rate of around 58 Hz. Higher transformation rates of the spectrum are not limited internally (up to 1280 spectra / s) but used for further processing (audio generation or retention of maximum values) for example.

The maximum spectral width of 163.84 kHz is the constant time-frequency transformed bandwidth of the RDR52 receiver. All further signal processing (with the exception of the time-based demodulators → range limitation by band filters) takes place within this range. The width of the audible bandwidth inside this spectrum is determined by setting the demodulation filter bandwidth.

### - Spectrum level adjustment

The level adjustment of the spectrum is displayed on the right side of the spectrum diagram.

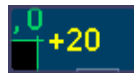

**Set value for the upper limit of the spectrum.**

The vertical (level) position of the spectrum can be changed by selecting and changing the value for the upper limit. This value has a special function when double tapped (single tap if already active): Switching the spectrum view between line spectrum, filled spectrum and waterfall (see "Setup" dialog).

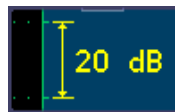

**Set value for scaling per subunit (resolution is always 40 display lines/sub).**

The level resolution of the spectrum can be adjusted via the value for the scaling per subunit.



**Display for the lower limit of the spectrum and the unit of measure.**

The unit of measurements can be switched in the Setup dialog between dBm and dBμV. This display-only value is not selectable for settings. However, when tapped, the level position is automatically shifted. To do this, the RDR52 constantly measures all visible spectral lines in the diagram and tries to determine an average value while neglecting the signal peaks. This mean value therefore approximates the mean value of the general noise ("Noise line"). This is indicated by a small yellow square on the right-hand side of the diagram.

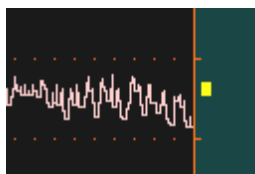

If you tap on the lower display of the level range, the level position is shifted in such a way that the mean value lies between the penultimate and last scale division. The shift always occurs in "even" values (upper level limit integer divisible by 10). This function enables a quick setting of the level position to optimal display after major changes of the noise line (e.g. switching of antennas or frequency change over ranges with differently strong receiving levels).

If the waterfall diagram is displayed, the level scaling and level settings will move to the waterfall color table (see description in the "Setup" dialog). Instead of the level scaling, the set value for the waterfall's speed appears. The mean value is no longer displayed, but the automatic setting function is still possible.

### - Video filter

The "Video filter" button is used to activate a filter function in the image processing of the spectrum display. To do this, you can switch between no filtering, average value filtering, maximum or minimum value filtering by continuously tapping the button.

- No filter: In case a high temporal resolution of the display is needed, the video filter should be switched off. The display will show a very highly dynamic image, with every change in the level (noise) displayed exactly as recorded.
- Average: Average of the spectral curves of multiple images. The displayed noise will be reduced as short-term maximum and minimum values do not appear in the display.
- Min / Max: The spectrum always displays the highest or lowest value measured since the last time the display was reset. Here all the detected values are recorded at full processing speed, even if this is above the frame rate (vertical period) of the display, so the actual maximum value might normally not be seen in the display. Setting for measurement and monitoring purposes.

The averaging rate of the average filter or the reset rate of the minimum / maximum value filter can be changed via a set value that becomes visible below the button when this filter is selected. It can be set from 0 (= reset with each new curve) up to 128 (averaging over 128 curves) or 9.8 s and then on to "infinity" (Min / Max).



**Defines the maximum hold time for an unlimited measurement.**

The unlimited measurement time allows the detection of transient signals (monitoring function), which are then displayed as long as desired.

**Caution!** Any change in the measurement period or the filter function leads immediately to a reset the display!

### - Menu

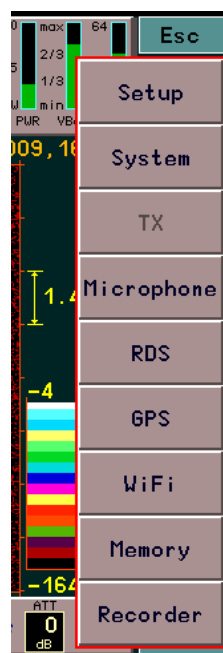



Tapping the virtual "Menu" button opens a selection (menu) of various other settings (so-called "dialogs"). The menu can be closed again via "Esc", without a dialog being called. A dialog is opened by tapping the corresponding area. Depending on the device and software version, different dialogs are available (see section "Dialogs").

### - Surround sound

The RDR52 possesses 2 audio channels that can operate independently within the 164 kHz SBSP reception bandwidth. Internally, channel 2 is programmed for phase-shifted reception of the same signal as channel 1 (which can be heard on both channels without surround sound).

With FM-W, the two channels carry the left and right stereo signals (when turned on). All other time-based demodulators do not have a pronounced surround sound function. With DSBQ, L/USBQ and DIGI, the signal is output as an IQ signal instead. Thus, it is suitable for feeding it into the sound card of a PC, whereby the RDR52 can serve as a high-quality SDR receiver. (However, the reception then deteriorates to "SDR level" by the inevitable interference of the PC.) In terms of hearing, the location of the sideband position (LSB = left, USB = right) is determined by the IQ output.

The effect of the "surround sound" function while using the SBSP modes is highly dependent on the settings. In certain settings, a good effect can be achieved. In addition to bandwidth and shift the exact tuning is primarily of importance. Even a small change in the reception frequency can change the effect, just as the change in the frequency position of the calibration (see the "Memory" dialog). Try different settings if necessary.

### - S-Meter

In the upper panel of the display there is a S-Meter, which is similar to those in analog receivers.

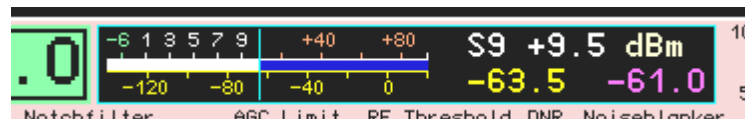

The instrument shows (above S values with decimals, and S9 +xdB or S0 -xdB, down scaling in dBm or dBμV) the current level on two scales inside the audible frequency range with a fast "pointer". To the right there are the smoothed averages (0.8 s) displayed as a digital value. The purple number value indicates the current position of the control / gain setting (upper horizontal line marker). The current unit of the numerical values is also displayed; they can be selected in the "Setup" dialog.

Readings for the S-meter are derived directly from the audible (yellow) portion of the spectrum. The video filtering is also regarded. Unfiltered values, average values or the currently accumulated maximum / minimum value are displayed.

When selecting a CW or SSB demodulator, however, it is always a "quasi-peak" reading. Each detected peak value is displayed for a short time, then the value slowly fades down to the current signal level.

### - Volume control

The lower panel has 2 virtual sliders for adjusting the headphone (left) and speaker volume (right). The slider can be dragged to the desired position. You can also tap directly to the desired position. At low levels, the setting is then immediately changed, at higher values, the position moves slowly out to it to avoid a sudden high volume.

The sliders can also be adjusted by rotating the volume knob. Thus, bigger jumps due to the inaccuracies of the touchscreen operation are avoidable. Which controller the knob affects is indicated by a red button of the corresponding slider. Switching between headphones (HP) and loudspeakers (LSP) is done by briefly pressing the rotary knob.

The leftmost position of the control mutes the respective output. In the case of the loudspeaker, the entire amplifier (clocked D amplifier) is then also switched off (power saving, prevention of interference from the clock).

*Note:* If the internal loudspeakers are deactivated ("Setup" dialog), the controller acts on the line output of a possibly installed module C5 ("System" dialog, setting value "AF Level %"). Devices connected there (e.g. active speakers) can be adjusted in volume.

*Note:* With an active Bluetooth connection, the volume of the transmitted audio signal can be changed with

the HP controller.

*Note:* The volume control operates with a logarithmic characteristic. Low volumes are changed sensitively, larger ones in coarser steps. Higher volumes are therefore only achieved when the controls are pulled relatively far to the right.

### - Slider parameters holding time and rate of increase (Hold and Attack)

The automatic regulation of the RDR52 (see description "Control Limit" / "AGC Limit") can increase the volume of the reception level so far that a signal at the control limit reaches full volume. As long as this limit is not reached (purple marker / displays in the S-meter are above the control limit) and the levels in the audible range are below the marker line, the automatic will continue to increase the volume. The speed with which this happens is adjustable with the value "Attack".

The increase ends when the signal level is reached (and always at the control limit). If the level falls, the regulation begins only after a waiting time with the further increase of the volume ("hanging" control). The waiting time can be set with the value "Hold".

*Note:* The reception level within the listening area is measured in the SBSP modes for each yellow spectral line individually. The highest line is used. The control therefore moves to the top of the highest signal. Only with very unsteady signals (for example noise), a certain addition and averaging of several lines take place. In this case, the control does not go all the way to the highest peak. The same happens within the time-based operating modes, wherever the overall level within the listening area is evaluated broadband.

*Note:* The measured values of the control are also used for the display of the S meter (scale and yellow value). This means that a narrow-band measurement in the SBSP operating modes takes place, in the time-based operating modes a broadband. This affects the display when measuring non-sinusoidal signals (especially with noise).

**The setting of the 3 control parameters control limit, hold time and control speed has a great influence on the listening quality.** Here are some tips:

- A suspension control is needed especially for the reception of SSB signals. Here, the hold time should serve to bridge the speech pauses within a passage. For this purpose, holding times of at least one to several seconds should be selected. The control speed should be low (a few dB / s).
- With AM broadcast reception, the control responds to the carrier height. As long as no strong fading occurs, hold time and speed can be set to low values. With stronger fading the speed can be increased.
- The control speed can theoretically be set very high (max 99 dB/s). But do not succumb to the temptation to "rule out" any fading with a high control speed! Often, strong fading is also very selective. That means that the carrier varies differently than the modulation sidebands. If the control follows immediately and exactly to the carrier, the modulation is "tampered".
- **Important:** The control limit should not be below the current reception level. In longer speech pauses (SSB) or when tuning, the control otherwise moves uncomfortably far into the noise. Compared to an analog device, the RDR52 then has an extremely high "gain". It is thus able (with a correspondingly low setting of the control limit) to even reproduce his own low intrinsic noise even at maximum volume. The control limit should therefore always be at least 10 – 15 dB above the noise line (observe the square marker on the right of the diagram).
- As always: The best automatic is the one that you can switch off! For borderline reception, the control should be switched to "manual" (Setup). With the control limit (now called "Gain") you can then adjust the volume yourself.

### - Attenuator (ATT)

An always active high-sensitivity preamplifier is built into the RDR52. It determines the limit sensitivity / minimum noise of the device. The highest possible reception level that can be processed is determined by the onset of overloading of the ADC (IM and reciprocal mixing ignored). In order to shift the dynamic range to higher levels as required, an attenuator is installed. It can be set in 1 dB steps from 0 to 31 dB.

The setting of the attenuator has a key role in the receiver's adjustment to the input level (antenna, location, ambient noise / interference, ...). It should only be set to small values or even zero if the external noise (antenna noise) is equal to or less than the receiver's inherent noise. Usually it is significantly higher.

A good setting is a value at which further reduction no longer results in an improvement of the audible signal-to-noise ratio. If no signal is received, the attenuator can be adjusted appropriately by observing the noise line in the spectrum and / or the S meter display. The value is correct if a further reduction just does

not result in a lowering of the audible and measurable noise level any more.

If very strong signals are received, an overmodulation of the device may occur (frequency indication lights up red). The attenuator must then be increased until the overmodulation stops. If this can not be achieved even with the maximum setting, the permissible input level of the RDR52 is exceeded and must be reduced!

For devices with an FM receiver, the attenuator is located behind the first FM preamplifier in the signal path. Thus, it hardly reduces the sensitivity with small settings. However, it cannot avoid overmodulation of the preamp. Overmodulation of the preamplifier generates strong distortions (IM). If the attenuator has to be set to high values while being in the FM range, it is better to reduce the antenna voltage externally.

*Note:* Do not succumb to the temptation to achieve a high signal-to-noise ratio while using very small attenuator settings! This is almost always determined by the antenna noise and the noise picked up by the antenna. Unnecessarily small settings instead diminish the RDR52's ability to suppress distortion (IM) and overmodulations (peaks in the antenna's buzzing level).

### 5.3 Other displays

On the right side of the upper panel are various bar displays for the RDR52's internal values.

- Mod (modulation level): The level of the microphone channel for modulating a transmitter.
- PWR (Power): Current power consumption of the transmitter.
- SWR (Standing Wave Ratio). Is only active when the C3 module is installed.
- T (temperature): Transmitter module temperature (C3 only).

Depending on the parameter and value, the colors of the bars change between green (all in limit), yellow and orange (borderline) or red (out of limit). A red indicator normally results in the shut down of the unit. This does not apply to overmodulation (bar mod) or excessive SWV (only the transmitter switches off).

Especially in the case of excess temperature (bar T), a warning is first given by a flashing display between the video filter button and the menu button. After 60 s the RDR52 is then switched off.

Above the button "Surround" ("Stereo"), the currently active software version and the serial number of the device as well as the manufacturer name are displayed.

Above it is a display value for the current undo level (see description "System" dialog).

The selected level of the automatic tuning ("Setup" dialog) is displayed between the volume control for the loudspeakers and the set value of the attenuator.

On the right side of the lower panel, when receiving a FM broadcast station with RDS signal, the station's PI code is displayed.

Above the spectrum, program name and program type are displayed between the frequency displays and the spectrum width set values when receiving an FM broadcast station with RDS. Tapping a display opens the RDS dialog.

At the bottom left there are quick buttons for controlling the recorder (see also the "Recorder" dialog):

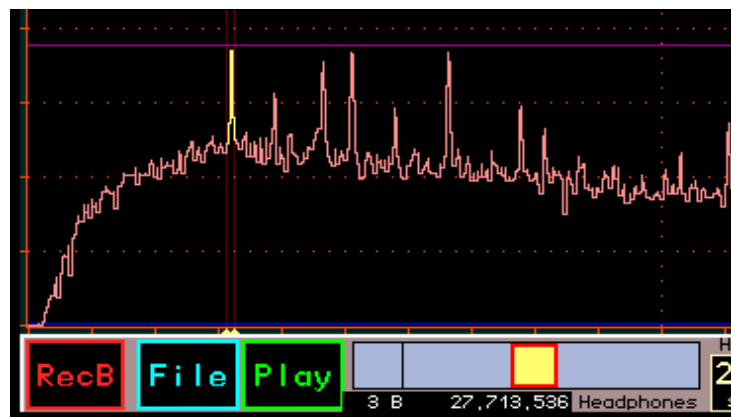

- **RecA(B/S):** Start / end of recording. "A" or "B" or "S" indicate which type of recording is taking place: Audio, Baseband (IQ) or Screendump.

- **File:** Tap this button to place the current input position on it (just like any change to the active input position). Then the current file can be adjusted with the Tune knob. It is displayed in a similar way to the entries in the Recorder menu as a small line below the headphone volume control. "File" can be disabled by tapping any other input position (e.g. frequency or volume), by the auto return function to frequency, or by tapping Rec or Play.
- **Play:** Start / end of playback of the displayed file.

While recording or playback is in progress, the File button changes its function. It is now called "Hold" and is used to pause recording or playback. As long as the function pauses, Hold is displayed as activated (as well as the current function). Tapping Hold continues the function, tapping the current function button ends the function.

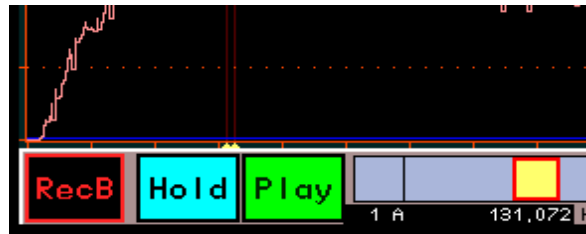

When the recorder's functions are initiated directly in the user interface (without opening the Recorder dialog), various operations of the RDR52 remain possible, others are locked. For example, no dialog can be opened. Note that changing the settings will affect the recorded or played back data differently depending on the type of recording (audio or baseband).

## 6. Dialogs

In addition to the permanently displayed user interface, different "windows" or "menus" are available, in which further additional options can be chosen. Those temporary views are called "dialogs". These can be accessed by tapping the "Menu" button and via the selection that pops up. Some dialogs can also be opened directly by tapping specific set values (such as "Memory" when tapping on the frequency).

In contrast to the normal display, the values are shown in dialogs with dark lettering on a light background, and they are selected accordingly by inverse display with light letters on a dark background. Color highlighted values allow an adjustment via the encoder automatic (see description in "Setup dialog").

### 6.1 Setup dialog

Opening the Setup dialog will pause the spectrum display and show the dialog within the display.



Most basic settings of the device's functionality can be adjusted in the Setup dialog, their adjustment during normal operation is rarely necessary. However, the current setting of some values is always visible in the user interface on the panel at the bottom edge of the screen (e.g. control or handwheel automatic).

The individual values are as follows:

#### - Automatic Handwheel

A value from 0 ("Off") to 14 sets the rotational speed of the tuning knob and automatically forces the adjustment without the need of user intervention. 0 is OFF, "1" is the lowest speed (slow rotation) and 14 the highest speed required to trigger the automatic mode.

The system monitors the movement of the scroll wheel and takes over its function, once a certain minimum number of pulses per second is detected. If this detection threshold is exceeded, the automatic system inserts virtual encoder pulses as sent by the keyboards operating system. These pulses cause exactly the same function (adjustment of a setting) as the operator would do using the scroll wheel. Tuning a frequency, for example, will have a flywheel effect.

The purpose of the process is to continue a running adjustment, even if the operator has stopped turning the knob. It tries to detect automatically the rate of adjustment in accordance to the measured rotational speed of the knob which is turned by the operator. Basically, only the tuning knob has to be "pushed" with a few steps, after which the adjustment of the selected value automatically continues.

Once the automatic adjustment has taken over the wheel function, it clearly indicates this by flashing a red icon in the lower panel of the display:

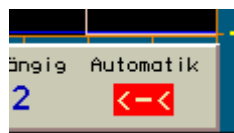

**The automatic encoder is active.**

The arrows to the left and a minus sign indicate the direction of the ongoing adjustment towards lower values (knob was turned anti-clockwise), and the ">" character and "+" symbol accordingly to higher values (knob was turned clockwise).

At low values of the automatic setting (activation even at low rotation speeds) a small automatic adjustment speed is initially provided, with larger ones a higher one.

During the automatic adjustment, the operator can always increase the adjustment velocity by further rotation of the scroll wheel in the current direction. The automatic mode detects these pulses and correspondingly increases the speed up to a maximum specified by the device (depending on the set about 10 - 100 pulses per second).

If the operator moves the tuning knob in the opposite direction, the automatic is immediately interrupted and the adjustment by the user in the opposite direction is executed. Therefore, the last automatic pulse is reversed effectively.

The automatic mode is also stopped under the following circumstances:

- A value on the touchscreen is tapped.
- The final value of a set value is reached (not fully apparent, although some final values prevent adjustment beyond this, but the automatic remains active and must be terminated by the operator).
- The upper horizontal marker (manual gain control or automatic gain control) is moved at least one position up or the received signal exceeds the marker within the audible area. This is especially useful when tuning, as it switches off immediately when a strong signal enters the audible reception area (station search function).
- Requesting a display scan via WLAN or Bluetooth.

The scroll wheel automatic mode is not available for all set values, but only for those with more than about 20 possible values. In dialogs, these values are highlighted in color.

There is a speed-dependent acceleration function when adjusting the frequency, which is also controlled by the encoder automatic. It increases the tuning step size with fast turning. The tuning acceleration effect is adjustable if no "Auto" is displayed before the value. (A value with "Auto" generates the automatic tuning.) The display of the automatic in the lower panel shows the setting of the tuning acceleration in green (red shows the normal automatic tuning).

## - Spectrum Touch

This value can be used to define various actions that are to be carried out when the touchscreen is touched in the area of the spectrum or waterfall diagram. The following options are available:

- No Action

Touching it has no effect.

- Track Frequency

Touching the touchscreen and dragging it to the left or right always changes the reception frequency. The adjustment is always made with the set step size. With each dragging over a distance of 4 pixels of the screen, a step is executed.

*Note:* If the step size and the visible spectrum resolution are adapted to each other according to 4 spectral lines / step (do some calculations), the tapped point of the spectrum follows the dragging movement exactly (as if it were "stuck" to the finger / stylus).

- Track Setting

As above, but the set value currently selected as active is "dragged" (changed up or down as with the "Tune" knob).

- Tune + Track Frequency

When you tap on a point in the spectrum / waterfall, the point you tapped is immediately set as the

reception frequency. Tuning is performed within the grid of the tuning increment. After tapping, the frequency can be dragged (even if not active as a set value).

- Tune + Track Setting

As before, except that the currently active set value is changed when dragging after tuning has been performed.

When using these functions, it should be noted that a touchscreen always has a few pixels inaccuracy. If you tap with your finger, this inaccuracy increases by the area of the finger recognized by the screen. It is therefore recommended to use a suitable touch pen (also called "stylus"). The fundamental deviation of the touchscreen from the visible screen is largely constant. With a little practice / experience you will quickly know how far from the visible (desired) point you have to tap in order to hit it exactly.

With the combination of "Tune + Track Setting" and selection of the spectrum resolution as the active set value, precise tuning over large frequency ranges (e.g. entire FM band) can be quickly achieved (max. 2x tap) after a little practice:

- Set a relatively coarse resolution (large viewing width). Spectrum resolution must remain active.
- Tap on the desired spectral line (tuning close to the desired frequency).
- Without letting go, pull to the left ("zoom in").
- Let go and then tap again with a high resolution (usually precise tuning immediately if the transmitter is in the grid).
- Before releasing, zoom out to the right again to a large viewing width.

### - Display Diagram

- Curve Spectrum: The spectrum is shown as a connecting line between the level values in each spectral line. The usual representation of a spectrum.
- Line Spectrum: Each spectral line is drawn from the lower boundary up to its level value (equivalent to "fill" the display below the curve spectrum).
- Waterfall: The spectrum is shown as a waterfall diagram.

So-called "waterfall plots" are an important tool for recording and documenting signal changes over time. Thus, each recorded two-dimensional spectrograph will not be displayed with the frequency on the x-axis (horizontal) and the signal level on the y-axis (vertical), each new plot overwrites the old one immediately and irrevocably. Rather, the level meter will now be scaled to almost the depth level (z-direction). Since this third dimension in a graph is not possible or representable, the level is now coded in colors and the spectrum is written as a one-dimensional line in the diagram.

Imagine that you would grasp the usual spectrum display with your hands on the left and right. Turn it 90° around the horizontal axis with the "tips" towards you and now look at the edge of a thin "spectrum disk" from above which would make the peaks closer to them brighter and the more distant "valleys" darker.

These quasi rotated panes viewed from above are now drawn consecutively on the display, with the older panes sliding down one position and the edge of the newest pane being viewed appearing in the top line. The newest one is always drawn on top, the oldest slice disappears below the diagram.

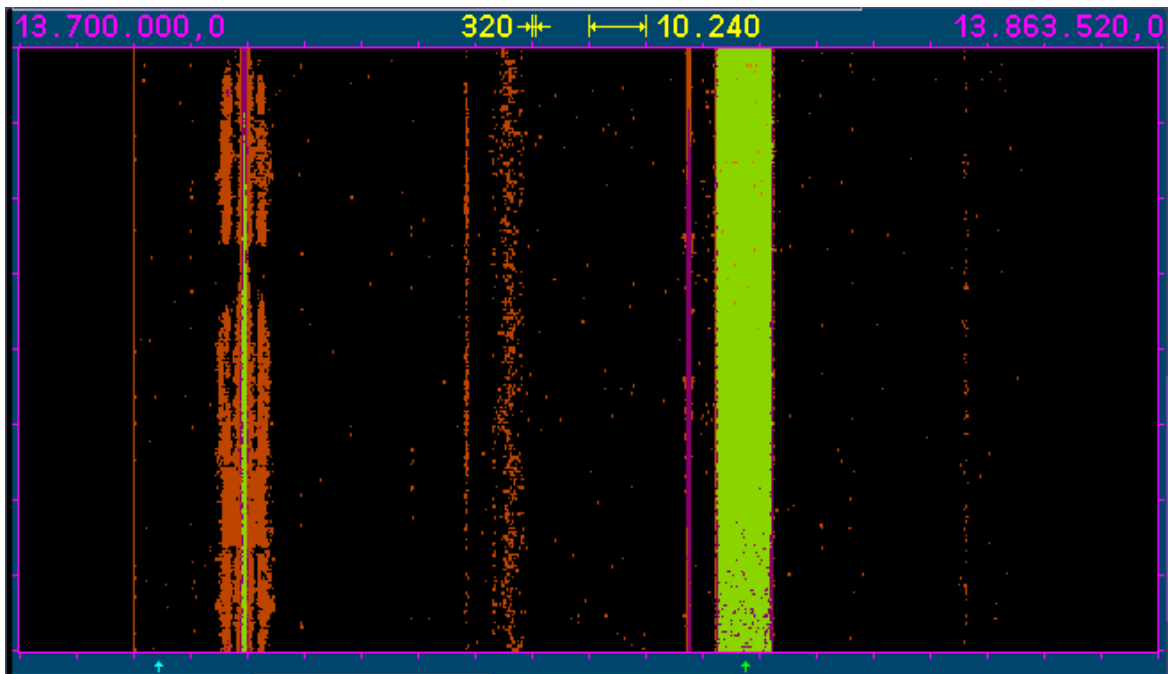

The effect corresponds to a visual impression of a waterfall, hence the name of this display. The "fall velocity" can be selected in three steps.

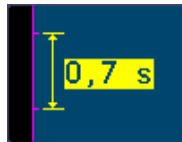

**The diagram is moved at a speed of 0.7 sec / unit = 17.5 ms / line (spectrum).**

*Note:* The calculation speed of the spectra is independent of the selected running speed and always equal to 4 times that of the selected spectral line width, in the example shown, ie 1280 spectra / s = 0.78125 ms / spectrum. To prevent data loss, select the mean or at very high data rates (for example) the maximum value for the video filter. Set the refresh rate to somewhat higher values than the line speed of the waterfall's one. If necessary, increase the line speed to the maximum value (0.35 s / unit = 8.75 ms / line).

Conversely, at high resolution and correspondingly lower spectra rate per second, possibly less calculated spectra are plotted as lines have to be drawn. That causes no data loss, but the plot is less informative, as more and more lines are drawn with the same content in succession until a new spectrum is available. In this case, reduce the speed of the Waterfall chart and / or turn off the video filter.

The view of the waterfall is heavily dependent on the "viewing depth" of the underlying level position in the diagram. The indication of the level takes place as color coding. Which colors are used for each level is shown in the color chart.

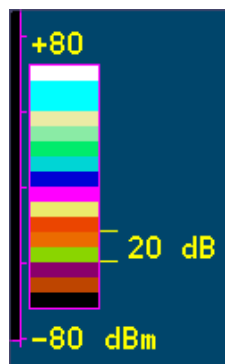

**The color chart shows the representation of the signal level in color steps.**

The colors displayed correspond exactly to the magnitude of the normal spectrum display and can be altered as well. The colors themselves can not be changed.

*Note:* Select the level position of the spectra (selecting the upper set value) for the highest possible contrast so that the area of your level of interest is displayed in large color differences. For example, the



noise threshold should be adjusted so that already little peaks of a signal are coded as a next color step. This way even low signal levels result in a clearly visibility trace above the noise floor.

*Note:* The diagram graphic can also be switched continuously by double tapping (single tapping if already active) on the set value of the upper level limit of the spectrum.

#### **- Loudspeaker**

Setting "On" or "Off". When switched off, the touch slider for the loudspeakers affects the parameter "AF Level %" in the System dialog (level of the C5 module's line output).

*Note:* Dragging the slider to zero (leftmost position) will also turn off the speakers. However, the slider is not switched to the C5 module.

#### **- Display Brightness**

Adjustment of the display's brightness in increments of 0 - 100%.

*Note:* When changing the display brightness below level 40, the brightness is set to at least 40 after switching the device off and on again.

#### **- Level Units**

Scaling (y-axis) of the spectrum or waterfall chart and the S-Meter in dBm or dBμV.

#### **- Gridlines vertical / horizontal**

Dotted lines in the spectrum graph to better view the sub-units.

#### **- RF Gain Control**

Adjustment of the the automatic control to "Auto" or "Manual".

#### **- FM-W Deemphasis (s)**

The correction of the emphasis of FM radio stations. "Off" for linear demodulation (only for measurement purposes), "50 μ" for the European standard, "75 μ" for the American standard.

#### **- Audio Lowpass (kHz)**

The signals pass through a digital low pass filter for filtering unwanted higher-frequency components before audio playback. Here, the cutoff frequency of this filter can be adjusted. Thus, if necessary, a height reduction can be achieved, e.g. with strong noise in the signal.

#### **- Audio Highpass (Hz)**

All signal processing in the RDR52 is "DC-coupled", meaning there is no lower limit frequency (or it is 0 Hz). Mismatches, low frequency deviations of the transmitter and receiver, interference, etc. could lead to the generation of DC voltage or low-frequency noise at the output. A digital high pass filter before D / A conversion prevents that from happening. Here, the cutoff frequency of this filter can be adjusted.

#### **- Impedance 0 – 71 MHz (Ohm)**

For devices with a special input amplifier (optional equipment), the input impedance can be switched here. Standard devices always have 50 Ohm (not changeable).

#### **- Resolution Audio (Hz/Bin)**

This setting affects the sound and adjustment options of the spectrum-based demodulators. It determines which spectral lines are made audible from the time-frequency conversion of the SBSP. 3 levels are possible:

- 10 Hz: Fine resolution with low ripples and distortion of audio generation. Spectrum update rate only 40 Hz, therefore large signal delay. Limited bandwidths of the demodulators (maximum audio frequency that can be generated is 5.1 kHz).

- 20 Hz: Medium resolution with low frequency ripple and normal harmonic distortion (SSB to SW). Spectrum update rate 80 Hz, moderate signal delay. Bandwidths of the demodulators corresponding to maximum audio frequency of 10.2 kHz.
- 40 Hz: Coarser resolution with higher ripples and fluctuating distortion of audio generation. Spectra update rate 160 Hz, low signal pass-through delay. Extended bandwidths of the demodulators up to the maximum producible audio frequency 20.4 kHz.

The setting should be made according to existing requirements (like fast signal passage in CW or Digimodes), according to the desired setting options (maximum bandwidth, granularity of the bandwidth's adjustment, shift, notch filter, etc.), as well as personal taste ("softness" or "clarity" of the audio playback).

### - Filter Bandpass

Adjustment of the HF prefilter. With "Auto", the filters are automatically switched according to the reception frequency. That way, the tuning above the filter or band boundaries is possible. For example, a skip from 30 MHz to 50 MHz is performed as soon as it is tuned beyond 30 MHz.

Setting a fixed filter / band limits the frequency setting to that band. An exception is the transition at 10 MHz. Here, both the lower and the upper range can be selected, tuning is always allowed between minimum possible frequency (demodulator and spectrum display-dependent) and 30 MHz.

If a filter is selected that is outside the current reception frequency, it will be set to the lowest or highest filter frequency (depending on where the frequency currently is in relation to the filter).

### - Antenna Control

With this setting a supply voltage can be output on the antenna connector 0 - 71 MHz. Suitable active antennas can be operated directly from the RDR52 without an additional remote feeder or external power supply.

The supply voltage can be modulated with a binary signal according to the RS-232 standard. This enables direct control of the antennas RLA4 and RFA1. An RSW control unit is not required in this case. However, an existing RSW3 or RSW4 control unit can be connected to the RDR52 via WiFi and this then takes over the remote control of the control unit (similar to the remote control software on PC, tablet, ...).

The following selection can be made via the "Antenna Control" set value:

- Off: No remote power supply or control of antennas.
- RSW: WiFi connection to an antenna control unit (further notes below).
- 7,1V: Fixed remote power supply with about 7.1 V at the antenna socket
- 8,6V: Fixed remote power supply with about 8.6 V at the antenna socket
- RLA: Control of the RLA4 (version D to G and following)
- RFA: Control of the RFA1 (all versions)

When selecting the settings with fixed supply voltage, any suitable antenna can be supplied via the connection cable ("remote supply"). The current consumption must not exceed 100 mA. The current is limited from approx. 120 mA. This means that the supply is short-circuit proof. Fixed voltage operation is indicated in the upper right corner of the display with indication of the current voltage:

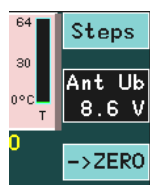

**Caution!** In case of a permanent current limitation the RDR52 heats up considerably! After a while the heat will be so strong that the protective shutdown responds due to excess temperature. This emergency measure protects the device, but is harmful to the electronics. Only operate the RDR52 under supervision when remote powering an antenna and switch off the remote power supply or the entire device when the antenna current exceeds 100 mA! These instructions also apply to the "RLA" and "RFA" settings!

The voltage is provided with a linear regulator directly from the supply voltage of the RDR52. The power loss resulting from the voltage difference times the flowing current is converted into heat in the RDR52. Therefore, if possible, the higher remote feed voltage should always be preferred (if the antenna can

tolerate it).

The direct control of the antennas RLA or RFA (from the specified versions) is possible by selecting the appropriate setting. In this case the RDR52 functions as an RSW control unit (see description of the RSW3 or RSW4 control units). As with the RSW, the connected antenna is fed with the low supply voltage and adjusted with pulses from the higher supply voltage.

The RLA can be adjusted in the receiving direction at an angle between 0° and 180°. The setting is made using the icon that can now be activated (can be tapped like any other set value) at the top right (current display only when an RSW is connected via WiFi in between, see below):

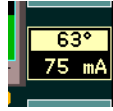

The RFA has 2 setting options: Frequency and resonant circuit quality. The setting of the quality in % takes place via the same value as the position setting of the RLA:

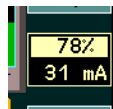

The frequency setting of the RFA occurs automatically concurrently with the frequency display of the RDR52. Each time the reception frequency is changed (coordination with the tuning knob, dragging on the spectrum, calling up a memory slot, ...) the corresponding control word is transferred to the RFA.

The RDR52 can also connect to a WiFi-capable control unit RSW3 (from version B) and RSW4 (from version A) via its WiFi interface. If the connection is successful, the control unit, and thus the antenna connected there, can be wirelessly remote controlled. RDR52 and control unit must be within WiFi range of each other.

The RDR52 takes on the position of the access point ("Access Point") similar to a WiFi router and the RSW takes over the position of the station that logs into the access point. A number of requirements must be met in order to log in successfully (see description of control units RSW3 and 4).

If the unit has been successfully logged in once (you may have to press the button on the RSW to start the process), the control can be set up at any time as follows:

- Set value Antenna Control in Setup to "RSW".
- Set the then visible serial number to that of the logged in RSW.
- Call up the "WiFi" dialog and activate the access point (if already active, deactivate it beforehand).
- Close the dialog, switch on the RSW.

After switching on the RDR52 access point and the RSW, the RSW first logs in (display "L" on the RSW display). The user interface of the RDR52 then tries to establish a data connection to the processor of the control unit. During this time, the following notification appears in the antenna control field:



If the connection was successful, the present measured current value and the position or quality setting of the antenna appear in the display (as shown above). "S" is displayed on the RSW. The set values are now exchanged bidirectionally between the devices. An adjustment of the set values on the RDR52 appears on the display of the RSW (and is used there for setting the antenna) and vice versa.

*Note:* The data transfer between RDR52 and RSW is very fast (a few ms) with a stable connection. However, the data transmission from the RSW to the antenna is slow (several 100 ms). This means that if the set values are changed quickly, the adjustment of the antenna is delayed (this also applies to direct control of an antenna from the RDR52 without RSW). However, the feedback of the values from the RSW to the RDR52 always shows the value last used by the antenna.

**Caution!** The frequency setting of the RFA is **not** bidirectional. This would hinder the RDR52's rapid frequency tuning. Therefore, the transmitted frequency values are only used by the antenna as its tuning speed allows. It is possible that the last step was not processed in the antenna when the adjustment was completed. Observe the tuning in the spectrum display and / or via the S-meter and switch the frequency

one step back and forth if there are any deviations so that the antenna can also process this data. Deviations are also visible in the antenna's display (version with built-in control unit) or in the RSW.

*Note:* If the data connection is interrupted (e.g. switching off the RSW), no further changes to the value in the antenna control field are possible (no more feedback from the RSW). However, the frequency can still be adjusted due to the non-bi-directional connection.

## 6.2 System dialog

When the dialog is open, the spectrum display continues.

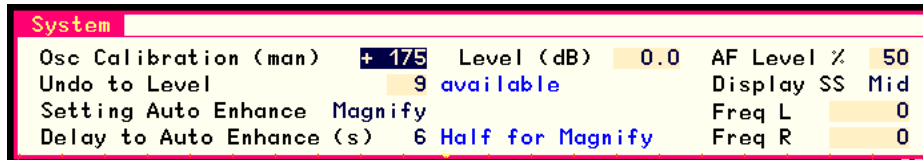

The following settings are possible:

### - Osc Calibration (man/GPS)

The main oscillator of the RDR52 is a temperature compensated crystal oscillator (TCXO) without any influence by a control, PLL or similar. As a result, it achieves extremely low values for the phase noise (important for high RF sensitivity and audio signal quality). On the other hand, it always possesses a certain deviation from the nominal frequency. That is, the frequency setting has some error.

This error can be corrected in 2 ways:

- Manual calibration ("man"): When selecting the set value in the System dialog, the frequency deviation in Hz can be compensated by setting an opposite (compensating) value. This requires the awareness of the current deviation. The deviation may be obtained by e.g. observing a very frequency-accurate signal (beacon, measuring transmitter, ...) in the spectrum. The calibration then takes place on the exact center position in the spectrum or "beat zero" with a DSB or SSB demodulator.

- Automatic calibration via GPS ("GPS"): If the GPS receiver is activated (see "GPS" dialog), the GPS receiver can determine the current deviation and enter the required correction value in the dialog. For this purpose, the set value must **NOT** be selected when the dialog is closed!

The distinction value selected / not selected (display "man" or "GPS") decides whether the device operates with manual or with GPS calibration. Of course, the latter is only successful when GPS is active (antenna connected and satellite reception is shown in the GPS dialog).

### - Level (dB)

An adjustment of this value causes a vertical shift of the display in all spectrograms by the set value and therefore a change of level readings. Use it when you need to make an accurate level setting using an external reference. Permanently connected preamplifiers or attenuators with their associated values can be calibrated here so that the correct level is always displayed within the RDR52 even despite preamplification / attenuation.

### - Undo to Level

The device constantly saves the last 28 operating steps that have been made. These settings can be recalled at any time (see description in Special features "Undo function").

Setting "0" always contains an unchangeable factory setting. It can be selected when the RDR52 is in an undefined state, which can not be remedied by switching it off and on again (it always saves all settings and returns there when switched on).

### - Setting Auto Enhance

The selection and display of the various set values of the user interface can be adjusted here. The setting options are:

- Off: Each setting is displayed normally and remains active until another value is selected by tapping on it.

- **Magnify:** As "Off". However, the selected value is displayed in double character size for a certain time (see below). The temporary magnification also occurs when changing the value with the tuning knob or by touch-dragging. This makes it easier to read the set values. Magnification does not occur under certain circumstances if it interferes with important other displays.
- **To Freq:** After adjusting a selected value, this value is only kept active for a certain time (see below). If no further change has been made within the time span, the active input location jumps from the selected value to the frequency display.
- **Mag+ToF:** Combination of the two functions described above.

#### **- Delay to Auto Enhance (s)**

Time in seconds after which the unit is switched to activate the frequency when the active setting is not confirmed. The "Magnify" function operates with half of this time.

#### **- AF Level (%)**

If a C5 module is installed (HiFi DAC), the level of the Line-Out output can be set here.

If the test generator (optional equipment) has been activated by setting calibration "+1995" or "+2000", the amplitude of the test signals can be set here. For further information, see the "Test generator" optional equipment section.

*Note:* This value is changed by the volume control when the internal speakers are turned off.

#### **- Display SS or FM Dev (kHz)**

Setting of the spread spectrum modulation of the display line frequency or the stroke at FM.

The display is one of the main sources of interference in the device. Due to its large area and the powerful and high-frequency control, it emits some interference despite good shielding and grounding. Especially the line frequency of approx. 46 kHz makes itself noticeable in the FM range as a "line grid" with a range of around 46 kHz. These discrete noise lines can be "blurred" by spread-spectrum modulation. The interference energy concentrated in the lines is distributed over several kHz width. The width of the distribution and thus the magnitude of the reduction on the discrete frequencies can be changed from "low" to "mid" to "high".

*Note:* The spread spectrum modulation of the display reduces the discrete noise lines at the expense of the background noise between the interference lines. This increases with the degree of modulation.

If an FM demodulator is set, the frequency modulation deviation for a transmitter (module C3 or C4) can be set here. If the optional equipment "Test generator" is available, the deviation of the test signals for FM modulation is also set here. For further information, see the "Test generator" optional equipment section.

#### **- Freq L**

When the test generator has been activated, the frequency of the first audio signal (normally used for left stereo channel) can be set here. For further information see section 10.2 and 11.2 "Special features".

#### **- Freq R**

When the test generator has been activated, the frequency of the second audio signal (normally used for right stereo channel) can be set here. For further information see section 10.2 and 11.2 "Special features".

The System dialog must be closed either with the "Esc" or the "OK" button. By tapping the "Esc" button, no further function is executed. However, calibration of the oscillator and level or frequency settings are always executed immediately after a change of setting inside the opened dialog and stored permanently.

When you tap "OK" and choose the current undo setting, the required function is always executed: The current device setting is completely replaced setting completely replaced.

## 6.3 Transmitter dialog

[Settings only effective for devices with transmitter or exciter, except "RX Delay ms" and setting of the jacks for microphone and key]

When the dialog is open, the spectrum display continues.

Transmitter		Offset Level	Mike Ring
Shift TX	0	Offset Phase	PTT In
PEP dBm	Off	Maximum SFDR	Key Tip
Delay RF ms	20	RX Delay ms	180
Risetime RF ms	1.0	SSB Shift Hz	100
			Key Ring
			CAT Out
			Baudrate
			9600
			Limiter %
			100

The parameters have the following meanings:

- **"Shift TX"**: Storing the transmission frequency at the set reception frequency (main frequency of the user interface) with positive or negative values up to  $\pm 19,999,999$  Hz. The transmitter can only be switched on if the main frequency  $\pm$  of the TX frequency lies within the permitted ranges. The TX frequency is always changed with the main frequency. In case the frequency is outside the valid ranges, the transmitter will be turned off.

*Note*: The adjustment of the TX frequency happens always with the same step size which is selected in the user interface for the main frequency. Similarly, the "->ZERO" button again has the function of setting to whole-numbered frequencies according to the step size.

- **"PEP dBm"**: Switching on / off and adjusting the output power of the transmitter depending on the version.

- **"Delay RF ms"**: The PTT Out switching output becomes active immediately with PTT In. The RF power is generated only after the time set here (allowing RX / TX switching of external PAs).

Example in the picture below: Switching time PTT  $\rightarrow$  HF = 5 ms (edge increase set to 1 ms):

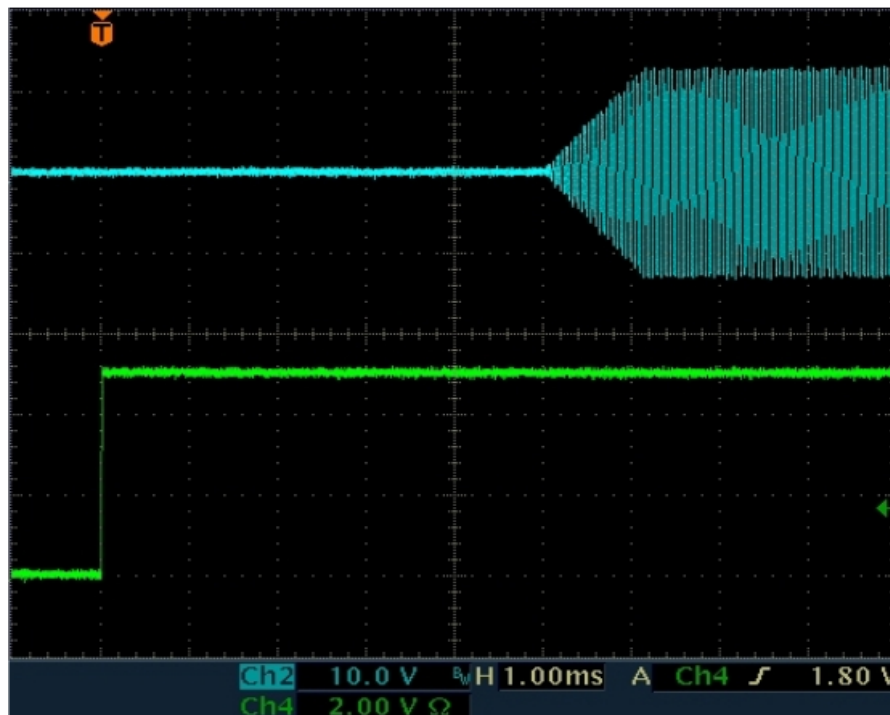

- **"Risetime RF ms"**: Rise / fall time of the HF power after switching the transmitter on / off (see picture above with edge time = 1 ms). Increase or decrease of power are strictly linear with no overshooting of any kind. In AM modulation (carrier on / off) or at an emergency shutdown of the transmitter the edges can be reduced to zero and overshoots can occur.

- **"Offset Level"**: Adjustment possibility of a polar modulator (C3) for minimum IM.

- **"Offset Phase"**: Adjustment possibility of a polar modulator (C3) for minimum IM.

*Note:* The signal quality in terms of IM headroom is dependent on frequency, modulation and manufacturing tolerances of the transmitter's components. The two offset adjustment possibilities allow a specific setting for one specific operating point of the transmitter, wherein a maximum IM headroom is possible.

- **"Maximum SFDR":** Adjustment to largest spurious distance. Adjustment to the largest spurious suppression. This setting is mostly unit dependent and only slightly temperature dependent in terms of spurious attenuation of the transmitted signal.

The adjustment should be performed at normal operating temperature and high frequency (after warm-up). A good frequency is, for example, 29.18 MHz. In the case of a large spectrum viewing width, interference frequencies can then be seen to the right and left of the carrier. These can be adjusted to minimum.

*Note:* When updating the software, or when loading the default settings ("Memory" dialog, Undo operation # 0), the calibration will be lost. However, they are always stored within a memory slot. The calibrations can therefore be easily restored from any memory slot.

- **"RX Delay ms":** Immediately after switching on the transmitter, the receiver is set to minimum gain (equivalent to "Manual" with -19.5 dB). After switching off the transmitter, it is hold in an insensitive state for the time of the "RX Delay" in order to suppress transients. After that time it is immediately put back on the defined maximum sensitivity ("Control limit" setting). Should the received signal now be stronger, the AGC is adjusted immediately. The signal "PTT Out" (control of external PA) is deactivated.

**Caution!** The value "0 ms" has a special meaning in connection with the monitoring (see "Microphone" dialog). In this setting, there is no switching of the AGC to the lowest gain value. The self-received transmission signal is therefore just as audible as any other received signal. For this purpose, no additional sidetone will be displayed.

*Note:* The "RX Delay" is the relevant parameter for the time needed from switching off the transmitter up to full sensitivity of the receiver. This time may be minimal if the TX signal is outside the reception bandwidth. However in case it is within (extreme: TX Shift = 0), it will be received depending from the RX / TX and RX switch settings. It will therefore control (if activated) out (regulate down). The gain control would only start increasing again after the set delay time and only at the set speed. It will be increased after the RX Delay time automatically to the full value.

*Note:* The parameter "RX Delay" is in the CW operation of particular importance, especially on CW VOX (VOX = 10 ms). With each trigger of the transmitter, the following sequence is started: TX-ON Signal (PTT / button / VOX) → process time switched output → Start rising edge RF → End edge RF → Signal → Start falling edge RF → End falling edge RF → Signal TX OFF (Switching output / RX trigger delay) → RX Delay → Set gain RX and falling signal PTT Out. By choosing a suitable RX delay, the operator can either choose to activate the RX as quickly as possible while accepting switching noises, or to minimize interference noise while accepting delays.

*Note:* This setting is also effective for devices without transmitters. Values above 0 make the RX insensitive when the "PTT In" input is activated (see below). This allows the RDR52 to be used as a parallel receiver to a transceiver or as a main receiver with a separate transmitter.

- **"SSB Shift Hz":** This value determines the position (lower audio cutoff frequency) of the transmit signal relative to the (suppressed) carrier in SSB modes. The effect is exactly the same as the effect of setting "shift" at reception. In all other modes, SSB-Shift has no effect.

- **"Mike Ring":**

- **"Key Tip":**

- **"Key Ring":**

The RDR52 has a jack for connecting a microphone and a jack for connecting a Morse key. Both jacks are 3.5 mm stereo jacks. They have 2 signal connections: "Tip" and "Ring" (or "Sleeve"). With the exception of Tip of the microphone jack (always microphone signal), these connectors can be assigned with different switching signals.

- **PTT In:** The connector receives the PTT signal to turn on the transmitter / mute the receiver. To accomplish this, the contact, which has a high internal resistance of 2.5 V, must be grounded by a switch or PTT switching output of other devices (< 0.4 V).
- **PTT Out:** The contact issues a signal to control additional devices. It is activated immediately on

activation of a connection assigned with "PTT In" or with "KEY In" and deactivated only after its deactivation plus set value "RX Delay ms". This can be used to control an external PA.

- **KEY In:** The contact receives the signal from a single-pole morse key to turn on the transmitter. To accomplish this, the contact, which has a high resistance of 2.5 V, must be grounded by the key contact (< 0.4 V).
- **CAT Out:** The connector outputs a serial data word (standard "RS-232") for controlling external devices (like PA). The data rate of the signal can be changed via the set value "Baudrate".

**Caution!** The signals "PTT Out" and "CAT Out" are 2.5 V CMOS level with approx. 700 ohm internal resistance! Especially the signal "PTT Out" is not a switching contact, open collector or similar with active "low" level! For use in common low-active interconnections, the signal must be converted by means of an external amplifier (transistor or IC)!

The generation of an RS-232 signal to control other devices is software-dependent (optional activation). By default, this signal is inactive (2.5V "high" level).

- **"Baudrate":** Sets the baud rate of the output signal "CAT Out".

- **"Limiter %":** If the transmitter is equipped with a signal compressor (e.g. module C4), the degree of compression can be set here. 100% means 100% pass of the microphone signal without compression. Smaller values compress the signal (raise small signal levels) so that levels at the set value are scaled up to 100% modulation level.

Example 50%: Microphone levels that would normally only modulate the transmitter at 50% now result in full modulation. All levels above this (50% to 100%) are compressed to 100% to avoid clipping. Compression is performed by sophisticated digital signal processing in such a way that no distortion occurs (no **simple clipping** of signal peaks above 50%).

*Note:* Using the variable limiter increases the average power of an SSB signal. This makes it easier for the receiver to understand under poor reception conditions. However, it also reduces the naturalness of speech and amplifies background noise (small levels are amplified higher by the degree of compression).

## 6.4 Microphone dialog

When opening the Setup dialog, the spectrum display is switched to the display of the signals at the microphone input (audio spectrum analyzer)



The parameters have the following meanings:

- **"Input:"** The microphone input is always unbalanced at the RDR52. This setting can not be changed.

- **"V bias:"** For active microphones 5 V can be selected as the bias voltage.

- **"Microphone level %:"** Volume setting of the microphone.

- **"ALC effect %:"** The microphone amplifier is equipped with an automatic level control (ALC). It reduces the gain at high levels to avoid clipping. The effect of the regulation can be adjusted here.

- **"Sidetone %:"** When transmitting, the receiver is set to minimum sensitivity, so that the transmitted signal is not heard in the normal case. If the sidetone is set to values not equal to 0, the modulation signal of the transmitter becomes audible. In CW, a sound is generated, which corresponds to the setting "CW tone" in the user interface. Negative values of the sidetone settings, create a phase shift of 180 ° in order to dampen any feedback which can occur.

*Note:* If no RX Delay is set (see above "Transmitter" dialog), there is no reduction in receiver sensitivity. Thus even the received broadcast signal is audible (if in range) and there is no side tone generated!



*Note:* In mode "SBCW" (combined SSB / CW) mode, when pressing the PTT key the SSB sidetone (microphone signal) will be generated; when keying with the Morse key the appropriate sideband tone ("L Freq" according to Memory dialog). Even if a double tone signal is sent into the sideband ("Freq L" and "Freq R" not equal to 0), only "Freq L" will be generated as a sidetone. In case "Freq L" = 0, then no sidetone will be generated, but a short-pulse (DC impulse).

- "**Squelch dB:**" Below the squelch level the microphone will be switched off. Only levels above this threshold generate modulation signals.

- "**VOX ms:**" hold time of the VOX (voice operated transmitter switching). When VOX is enabled (value > "off"), the transmitter is accessed as soon as the modulation depth exceeds the value "VOX level". The transmitter is switched off if the modulation level was below the VOX level for at least the set time.

**Caution!** The VOX can be switched off directly in the user interface if the "Stereo" button is set to "On". This allows a quick deactivation in case of noise (like a telephone call).

- "**VOX level %:**" The VOX threshold can be selected as a percentage of full scale. The full scale itself is adjustable with the microphone level setting and is indicated by the modulation bar in the transmitter display panel of the user interface. The VOX activates the transmitter when the modulation bar reaches the set threshold.

Setting a value with "AV" before the percentage will activate an anti-VOX circuit. This always sets the internal threshold to 99 % when a received signal in the demodulation range (yellow spectrum area) reaches the AGC threshold (setting "Gain Limit"). In the case of receiving a stronger signal the VOX is "deaf" and can only be enabled by a very high microphone level (full scale modulation). If the signal falls below the AGC gain limit (channel free), the VOX works with the set sensitivity.

*Note:* By selecting the AGC threshold, ie the point at which regulation begins, the allowable reception level can influence the threshold of the VOX. If one drives the system gain as high as into the noise, the anti-VOX is almost always active. The higher the AGC threshold, the stronger the signals that may be present in the channel without activating the anti-VOX.

The anti-VOX does not respond when the VOX turned on the transmitter. During the transmission period, the VOX tests microphone signals always to the set level. Only when the RDR52 comes back to reception, the anti-VOX monitors the signals in the receive band again and is able to "deaf" the VOX.

In split mode (TX Shift in Transmitter dialog does not equal to 0), the anti-VOX can only monitor signals on the RX frequency. Strong signals on a frequency outside the RX band (on the shifted TX frequency) have no effect on the anti-VOX.

- "**Bandwidth Hz:**" Bandwidth of the transmission signal. In FM it represents the cutoff frequency for the modulating signal. Selectable in different levels depending on the operating mode.

**Caution!** The transmission bandwidth extends for AM and DSB of both sidebands. The highest modulation frequency which will be transmitted is only **half the size** as the set bandwidth range. In case of SSB the transmission bandwidth corresponds to the transmitted **AF bandwidth**. For CW, the bandwidth setting has **no effect**. For FM, the transmission bandwidth corresponds to a value that results from the set **bandwidth and deviation** (see "Memory" dialog) according to the theory of frequency modulation.

**Caution!** In an SSB mode, the position of the bandwidth within the AF spectrum is determined by the set value "SSB Shift" in the Transmitter dialog! The lowest transmitted frequency therefore results from the value of the SSB shift, the top AF frequency of SSB Shift + bandwidth. This corresponds exactly to the conditions when receiving an SSB signal.

**Caution!** In SSB, the position of the filter **must** be defined relative to the carrier by means of the setting "SSB Shift" in the Transmitter dialog! If the value is set to small, the transmitted signal interferes into the wrong side band due to the finite slope of the filter (150 Hz for 60 dB attenuation)! At least 100 Hz should be chosen as a shift, so that no strong signal is generated in the wrong sideband.

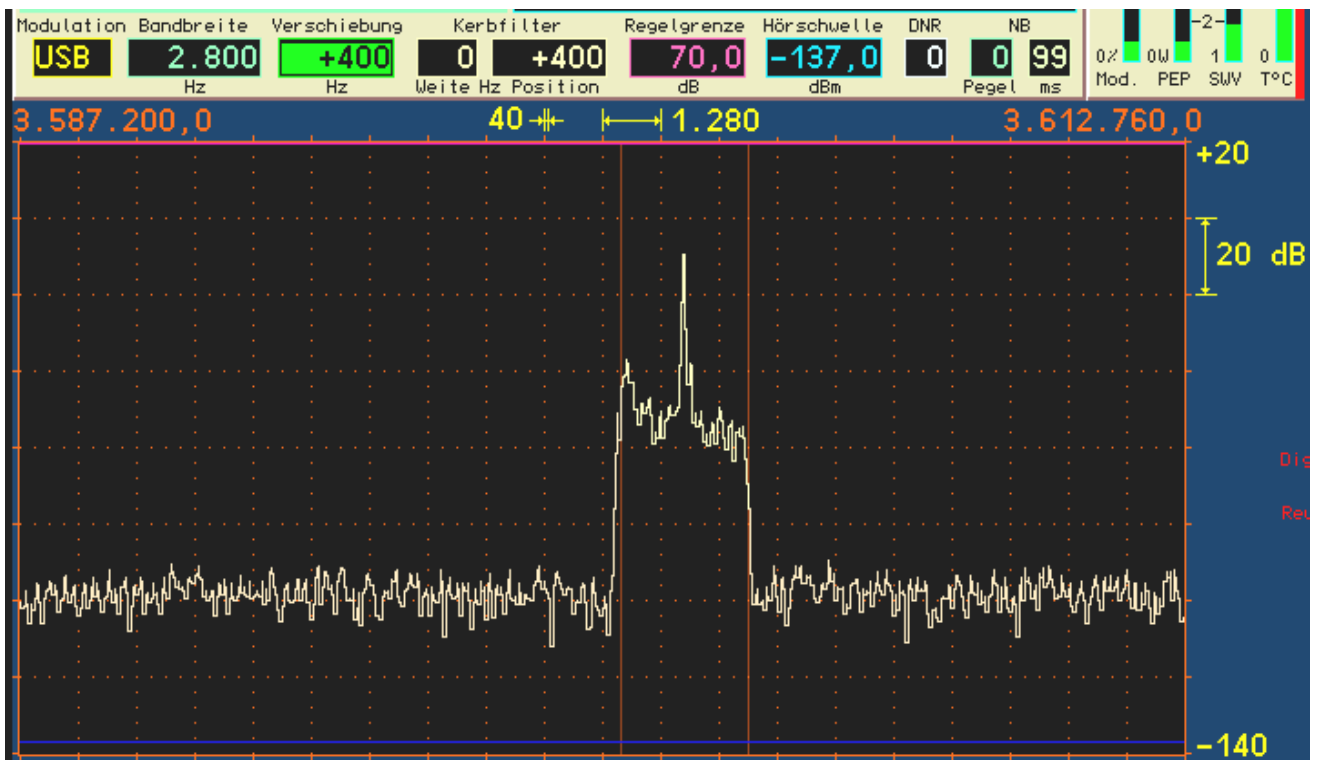

Example SSB transmission bandwidth 2.7 kHz at 400 Hz SSB shift (to provide a better view, RX shift was selected to be exactly the same here): The transmitted AF frequency ranges from 0.4 to 3.1 kHz.

- **"High pass:"** High pass filter to block DC voltage and attenuation of very low modulation frequencies. Can be adjusted in different levels. The high pass filter can be set to "Off". The microphone signal is then passed to the modulator inside the transmitter module without any influence. The bandwidth is about 80 Hz - 10 kHz. The bandwidth of the transmitted signal is then only determined by the transmitter filter ("Bandwidth Hz" setting).

*Note:* By bypassing the filter ("Off" level), the transmitted AF bandwidth can be extended slightly downwards. The signal then contains quite low frequencies of a broad-band and frequency linear modulation, for example in the AM or FM mode. For normal voice transmission in SSB radio mode, however, the high pass filter should always be switched on (prevention of low-frequency transmissions in the wrong sideband). The equalizer can then be used to set the frequency response for good speech intelligibility.

- **"Equalizer:"** Slider for frequency response. A multi-channel tone control network ("Equalizer") is installed in the microphone circuit. The appropriate frequency range's level can be raised or lowered with the sliders. The bandwidth of each range is designed so that adjacent frequencies can be influenced with a maximum of 3 dB.

Extreme example: all settings at maximum. Then, for any frequency other than the lowest and the highest, an increase of +18 dB is possible (+12 dB boost on their own, plus each of the adjacent frequencies +3 dB). The lowest and the highest channel will have +15 dB boost.

**Caution!** The equalizer is located behind the ALC in terms of signal flow! An amplification (increase) of the modulation signal can therefore not be compensated by the ALC and can cause overloading of the modulator with a hard limitation (distortion) of the signal. In this case unwanted spurious emissions rise over the allowed values of the transmitter! Adjust the settings of the equalizer in the positive range (increase) very carefully!

*Note:* The settings of the equalizer can be heard via the sidetone, or via the spectrum during opened Microphone dialog. The sidetone does **not represent the bandwidth limitation** according to the Microphone dialog! The exact transmission signal can only be monitored by self-reception when the setting "RX Delay" in the Transmitter dialog is set to 0.

Operation of the test generator

A test generator for the transmitter can be activated within the System dialog. The test generator is installed in the transmitter's modulator. It is activated as soon as a frequency setting of a test signal (Freq L

and / or Freq R) greater than 0 is present.

The test generator is especially useful to test and calibrate the transmitter. The generated signals have a very high quality (distortion level well below 0.01% THD, SNR > 100 dB) and do not intermodulate with another. In SSB modes, the transmitter's intermodulation can be measured in two-tone modulation and calibrated via the "Transmitter" dialog.

- „**AF Level %**“: Level of the test generator. It affects both frequencies equally. The full output of the modulator is achieved with 100% level, regardless of whether both or only one test signals are activated.

*Note:* The various filters in the transmitter have a certain amount of ripple in the passband (0.3 dB). At 100% level, it may come to clipping at certain frequencies. Then decrease the level setting by a few percent.

- "**FM deviation kHz**": In case FM modulation is selected (set value "Demodulator" in the user interface), the deviation can be set here. The value is for a modulation level of 100%. Depending of the demodulator (FM narrow or wide) both modulation types are stored separately and always used for the modulation of the transmitter. Common positions are 2.5 kHz for FM-N and 75 kHz for FM-W.
- "**Freq L**" and "**Freq R**": Independent frequency settings of the test generator. If set to "0" for both frequencies, the test generator is turned off. The frequencies are added in the transmitter's modulator. If both are active, each signal will be used with only 50% level to avoid clipping. The frequencies can be set in 10 Hz increments up to 1 kHz and above (up to max. 15 kHz) in 100 Hz steps.

*Note:* The terms "L" and "R" have no meaning for the transmitter.

*Note:* The test generator is not affected by filter settings for the microphone channel. In the FM modes the chosen bandwidth serves as upper limit.

### Mode "SBCW"

Besides being able to generate a test signal with the tuning operation ("Tune" button), the test generator has an additional task:

- Generate a sideband signal by pressing the morse key.

By pressing the PTT in mode "SBCW" normal SSB operation is established (automatic switching of the sidebands at / above 10 MHz). However, with (sole or additional) actuation of the morse key, an audio frequency within the sideband is generated whose level corresponds to the frequency setting of the test generator. With the level setting of the test generator, the volume can be influenced. It is also possible to activate both frequencies and to generate a two-tone signal within the SSB sideband.

**Caution!** The generated signal is not subject to the bandwidth limit of the transmission bandwidth (setting "Bandwidth" in the Microphone dialog)! Don't select a frequency setting that is outside of your desired SSB transmit bandwidth!

**Caution!** If at least one frequency setting of the test generator is greater than 0, the generator signal is also output in tuning mode (F2 "Tune!" button) instead of the carrier frequency. **In AM mode the AM carrier will be immediately switched on to full level** and will use the generator's signal only as a modulation signal!

## 6.5 RDS dialog

The RDS dialog can be opened via the menu or by tapping the program name or program type display. When the dialog is open, the spectrum display continues.

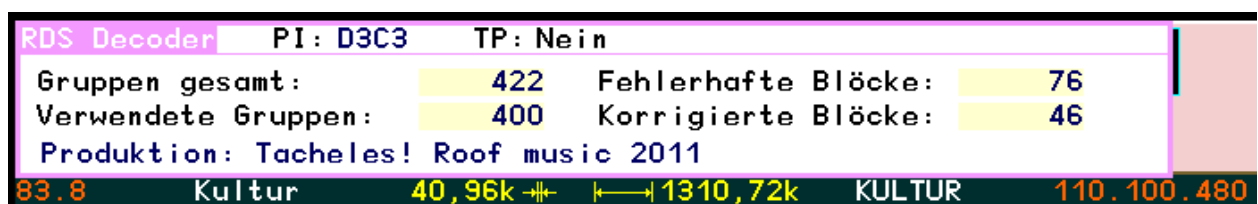

The RDS dialog contains various displays on the operation of the decoder. In the bottom line the radio text

(RT) is displayed. No adjustments can be made in the RDS dialog. It can be closed either with the "Esc" or the "OK" button. The device setting is not changed thereby.

## 6.6 GPS dialog

When the dialog is open, the spectrum display continues.

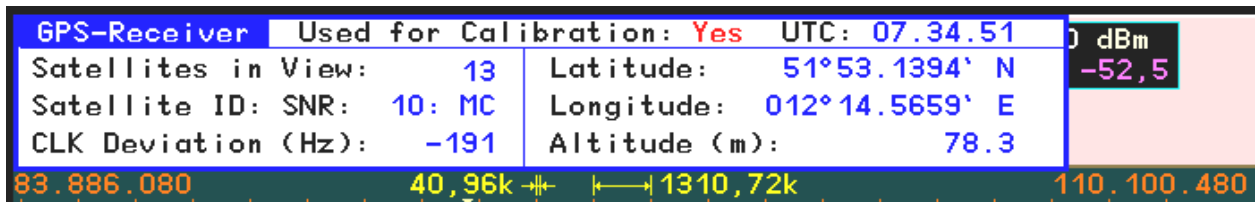

The GPS dialog contains various displays of the GPS receiver. Most values are only available when the GPS receiver correctly receives the satellites and can calculate the data. For this the antenna must be connected and have reception (direct view to satellites). In addition, the GPS receiver must be switched on in the "Power Management" dialog.

The following displays are available in the GPS dialog (no adjustments possible):

- **Satellites in View:** Number of currently available satellites. For operation at least 5 satellites must be receivable, highly accurate position calculations and frequency measurements are possible from 10 satellites.
- **Satellite ID: SNR:** The SNR of different satellites is displayed here in no particular order.
- **CLK Deviation (Hz):** The current measured deviation of the main oscillator from target frequency.

The GPS receiver enables the use of the atomic clock time base in the satellites as a reference for time and / or frequency measurements (using the 1 PPS signal). This 1 second signal serves as a time base for measuring the frequency of the main oscillator in the RDR52. It has a maximum deviation of  $\pm 12$  ns (if at least 5 satellites can be received). The clock period of the RDR52 oscillator is also around 12 ns. Thus the maximum measurement error is 2 periods = 24 ns / second =  $2,4 \cdot 10^{-8}$  (0.024 ppm). This corresponds to a maximum measurement error of approximately 2 Hz with respect to the oscillator frequency. The average measurement error when reception is good ( $\geq 10$  satellites) is below 1 Hz.

The measured frequency deviation can be used for automatic calibration of the RDR52. For this, the calibration for manual input must **NOT** be selected in the System dialog (see there). The use of automatic calibration is indicated by "Yes" in the title bar of the GPS dialog. With active manual calibration it will show "No" and the measured deviation is ignored.

During auto calibration, the current calibration value is constantly calculated from the measured deviation and used for the correction of all frequency settings and displays. There is no direct intervention in the control of the oscillator. This maintains the high phase purity of the free running crystal oscillator.

The automatic calibration calculates the value internally to 0.5 Hz precisely and can adjust it by a maximum of one step each second. When the oscillator frequency changes (for example by temperature changes), the readjusting speed is thus max. 0.5 Hz / sec. If the oscillator frequency deviates too far from the nominal value (for example, in cold state after switching on or manually adjusting the calibration over larger ranges), it will take a long time for the system to readjust to a deviation  $< 1$  Hz.

- "**Latitude, Longitude, Altitude (m):**" Latitude and longitude and altitude above normal zero.

No adjustments can be made in the GPS dialog. It can be closed either with the "Esc" or the "OK" button. The device setting is not changed thereby.

## 6.7 WiFi dialog

When the dialog is open, the spectrum display continues.

WiFi/BT-Configuration		MAC: AC:0B:FB:50:66:A1	Bluetooth Device
Mode:	Access Point	Channel: 13	no device
SSID:	Pocket_001	Antenna: external	no device
Passkey:	1234567890	Driver Update OFF	no device

The name field displays the MAC address of the network processor when the network is active. The set values have the following meaning:

- **"Mode:"** Operating mode of the network processor. "Off", "Access Point" and "Bluetooth" can be selected. The WiFi access point is switched on when the tune knob is turned clockwise, Bluetooth is switched on when the tune knob is turned counterclockwise. Parallel operation of WiFi and Bluetooth is not possible. After switching off an active mode there is a 2 second delay until a new mode can be selected.

**Caution!** To establish the wireless connection, the included WiFi antenna ("stub antenna") must be screwed to the correct connector. When connected to devices very close to the RDR52, RF overloads may occur (poor connection despite high levels)! In this case, remove the device from the RDR52.

**Caution!** Even if "Access Point" or "Bluetooth" is selected in the dialog, this mode is not automatically switched on after each restart of the user interface! To activate the WiFi transceiver, the dialog must be opened after each restart and the desired mode must be switched on.

With the Access Point turned on, the RDR52 establishes a WiFi network that other computers can log into to exchange data. For additional info, see section 7.3 "Software Upload".

If Bluetooth (subsequently called as "BT") has been activated, the RDR52 first searches for BT-capable audio devices ("Wait ..." appears briefly during the controller's initialization). The devices to be connected must therefore be switched on at the latest now, preferably before the BT activation of the RDR52. The search phase is indicated by the message "DiscoverBT .." in the Mode setting.

Detected devices are displayed on the right side of the dialog. The name of the device is displayed together with the reception level of the BT connection. The lower the values ("more" negative), the weaker the connection. Values down to approx. -75 dBm are sufficient for a stable connection. If the values are even lower, or if a device is not found at all, it must be positioned closer to the RDR52.

The RDR52's utilized antenna (along with the capabilities of the BT device) decides about the possibility of a stable audio connection. In addition to the displayed reception level, experimenting with the antenna orientation and the positioning of the BT device to the RDR52 may be required.

Like WiFi, Bluetooth is a broadband radio connection, of which the frequency (2.4 GHz band) is often used by several devices at the same time (like wireless routers, wireless headphones, wireless mouse / keyboards, microwave ovens, ...). If too many devices are operating at the same time, a stable connection may not be possible despite a good reception level. Switching off other devices or positioning the RDR52 and the connected audio devices out of range of these interfering devices may help.

After locating the first device, the RDR52's search phase for BT audio devices takes a maximum of about 10 seconds. If no device is found, the RDR52 remains in the search phase. If a third device is found, the search stops immediately. More than 3 devices can not be managed by the RDR52 at the same time.

After completing the search phase, one of the located devices can be selected for audio output ("Start Device" appears in the Mode setting). To do this, the entry for the desired device can be tapped in the dialog. The RDR52 will then try to connect to the device. If a stable connection can be established, the audio signal is transmitted and can now be heard on the device. "Play!" is displayed in the RDR52's dialog during the transmission to the corresponding device. The dialog can now be closed and the RDR52 can be operated as usual.

The volume level can often be adjusted directly at the utilized loudspeakers and headphones. However, this can be cumbersome, for example when the speakers are positioned further away. In this case, the devices should be set to full volume and adjusted via the RDR52's headphone volume control. On the other hand, it is possible to move away from the RDR52 with worn BT headphones. In this case, the RDR52's volume level should be set just short of maximum volume (depending on the audio signal, full volume might already cause overmodulation) and the headphone's volume control should be used.

The located devices can be switched in the WiFi / BT dialog by simply tapping on the desired output device. The currently connected one is then decoupled and the desired connected. If less than 3 devices are listed, the transmission to the currently used device can be interrupted by tapping an empty entry ("no device"). Switching off the Bluetooth function (turning the Mode setting clockwise to "Off" with the scroll

wheel) decouples the current device and switches off the WiFi controller. A restart will initiate a new search. If the device that was connected last is found again, a new connection to this device is established immediately.

- "**SSID:**" The name of the generated network. This always consists of the word "Pocket" and a hyphenated 3-digit number. The number can be changed (only if Mode is set to "Off").

- "**Passkey:**" Password (BSSID) for access to the network. The RDR52 WiFi network uses "WPA / WPA2-PSK" encryption. To be able to log in to the network, a client must transmit a password and a network name. The RDR52's password always consists of 10 digits. The digits can be changed (only if Mode is set to "Off").

*Note:* Encryption with only 10 digits is not very secure. Since the RDR52 does not have any "usual" operating system (for example, Windows or Linux), no malicious code (viruses, trojans, etc.) can be active in the RDR52. An attacker could however intercept the transmitted data packets.

- "**Channel:**" Radio channel in the 2.4 GHz band on which the RDR52 builds its network. The channel can be selected in the European range between 1 and 13. Select a channel that is used as little as possible by other nearby access points (e.g. WiFi routers) and is not disturbed (e.g. by microwave ovens). Channels at the end of the band (e.g. channel 9 or 13) are usually favorable. The current occupancy of the 2.4 GHz band can be checked using simple tools such as a "WLAN Finder" app on a smart phone or a display in WiFi router software.

- "**Antenna:**" The RDR52 has no internal antenna and only one connector for an external antenna. This connector is always on and cannot be changed.

- "**Driver Update:**" The software of the network processor (also called firmware or "driver") can be updated independently of the device. For this the access from a network client must be enabled here (setting to "On", only possible with active access point).

**Caution!** Never switch on the access during normal operation! Accidental modification of the software can lead to the complete loss of functionality of the WiFi network! No new downloading of the driver is possible afterwards! In such a case, the device must be reprogrammed by the manufacturer.

For more information about operating the network and transferring data, see section 7.3 "Software Upload".

## 6.8 Memory dialog

The dialog is used to enter values directly and to manage the memory slots. Opening the dialog will pause the spectrum display and show the dialog within the display.



The Memory dialog can be opened in 2 ways:

- Method 1: Tap the active frequency display (double tap if frequency is not active).
- Method 2: Selection from the menu.

The left side always shows 11 memory slots as an extract of the freely available 199 slots. An occupied slot is always designated by the pertaining demodulator and the frequency. The section list can be moved up and down ("scrolled") by turning the tune knob. The order of the memory slots depends on whether the frequency display is active when the dialog is opened (always with method 1):

- Frequency active: Order by ascending frequency (as in the picture above).
- Frequency not active: Order by slot numbers (numbers on the far left, as in the picture below).

When tapping a **slot name (frequency)**, the dialog is closed and the RDR52 immediately configures itself with all data from this slot (complete device setting as it was when saved).

When tapping on a **slot name (demodulator)** the dialog is closed and the RDR52 immediately configures itself with only a few selected data from this place.

The slot entries in the memory dialog are separated by a yellow line between the demodulator name and the frequency. If a slot is selected by tapping on the frequency (larger field), the complete device setting is set to the values of the memory. If, on the other hand, you tap on the demodulator name (smaller field), only the frequency, the demodulator and the bandwidth (possibly with dependent parameters such as shift and notch filter ...) are set according to the memory. All other parameters such as volume or display brightness... are kept.

If you tap on the "S" in a slot line, the current configuration of the device is prepared to be saved in this slot (indicated by the yellow border). All adjustable set values of the user interface and all dialogs are always saved. Tapping the outlined "S" again saves the values to the slot. Any values already present there will be overwritten. Tapping on the slot number, on "Esc" or calling up a memory slot cancels the save function.

When "C" is tapped, the memory slot is prepared for deletion. Tapping the outlined "C" again deletes all values in the slot permanently. A deleted slot is "empty" and selecting it has no effect, the current setting of the device is not changed. Tapping on the slot number, on "Esc" or calling up a memory slot cancels the delete function.

To make working with the memory easier, when using the 2nd method (selection from menu) a memory preview with calling up the memory slots without tapping a slot and without closing the dialog can be activated. When scrolling through the memory slots, it is always the 2nd slot from the top that will be loaded into the receiver settings. Loading is done via the partial method (like tapping the demodulator name to the left of the yellow dividing line). That means, only the frequency, the demodulator and the bandwidth with dependent values (Shift, Notch filter, ...) are set. All other values such as volume, display resolution or screen brightness are not loaded and are retained.

**Exception:** The stored value for the control threshold (violet line) is also restored so that it can be quickly adjusted to the current level.

The signal from the memory slot can be heard immediately. With the RDR52, however, the spectrum is also a very important criterion for assessing reception. In the spectrum-based operating modes, it is actually absolutely necessary to make the signal audible. Therefore, when called via the 2nd method, the spectrum is also activated. The result is a "transparent" display of the memory dialog with the spectrum visible in the background.

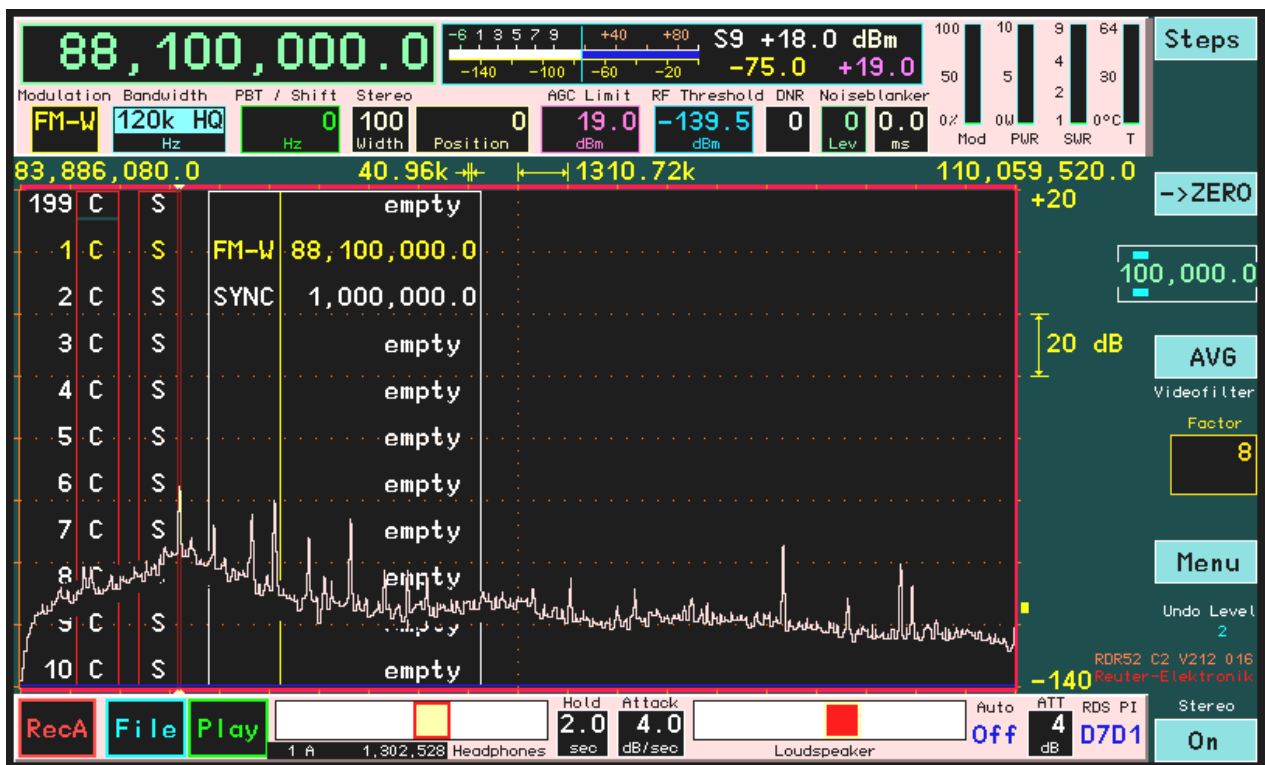

The list of memory slots with the 2nd (now active) entry highlighted in yellow is "eaten up" by the spectrum. However, since the spectrum does not normally extend to the top of the diagram, the entries visible there are retained. (Otherwise, the spectrum height should be adjusted accordingly before calling up the dialog, most simply by tapping the lower level position and thus automatically setting the noise line to the lower diagram area). With each scroll step the list is moved as usual and rewritten over the spectrum. Empty entries or entries for DAB programs are not called. The memory preview does not work in DAB mode.

To stop the preview, a slot must be called up (tapping the desired line). As long as the preview is active, no further settings in the dialog can be made (no direct entries or calling up DAB or canceling with Escape). The corresponding buttons are therefore not even displayed. Editing of the memory (deleting or programming of slots) is possible.

The virtual numeric keys and the "MHz OK" and "kHz OK" buttons allow frequencies to be entered with the corresponding power of ten, whereby a maximum of one decimal place can be entered in each case. Completion of the digit input with "OK" processes the value directly without further scaling.

Example:

Input sequence "1 → 0 → , → 1 → MHz OK" with direct frequency input results in an adoption of the frequency 10.100.000.0 MHz into the frequency setting. It should be noted that entries that are too large or too small are limited to valid values, or a change to the relevant area takes place (pre-filter automatic mode). Only one more digit can be entered after the decimal point.

The "←" button deletes the last digit entered or the comma.

Various other set values besides the frequency can also be changed via the digit entry. For example, you can set a shift in the listening area (PBT) in the SBSP modes by directly entering numbers and tapping the "OK" button. This is faster for larger changes than for the knob or swiping over the spectrum.

The dialog must be closed with one of the OK buttons or the ESC button within the dialog (except for preview view). When a memory slot is called, the dialog is also closed immediately.

The "Discover DAB" button is only available on devices with FM module (C2). Tapping this button starts a full DAB search without having to turn the RDR52 off and on again. For more information, see the section "DAB reception".

### 6.8.1 Entering an activation code

The Memory dialog is also used to enter activation codes to unlock additional optional equipment. This allows the activation of certain additional options such as broadband spectrum, FM filter or extension of the



flash recorder memory regardless of the software installed at the time of purchase or a later update. To activate one or more options (fee required), a specific code must be entered in the frequency input of the Memory dialog (opening the dialog when the frequency setting is active). This code only applies to a specific device with its permanently burned serial number. Thus, the activation is permanently bound to this device and can never be deleted (except at the manufacturer).



Memory dialog after successful entry of the code and activation of an option

The code must be entered as a frequency input with a comma before the last digit and confirmed with "MHz OK". If it corresponds to the device and was authorized by the manufacturer, "OK" appears in the frequency display. After switching the RDR52 off and on again, the corresponding option(s) can be used.

*Note:* When requesting an activation code, always state the serial number of the RDR52 (type plate on the back, display at the bottom right of the screen)! The code is valid only for this number.

## 6.9 Recorder dialog

Opening the dialog will pause the spectrum display and show the dialog within the display.



The RDR52 has a fast flash memory for real-time recording of audio or IQ baseband signals as well as screen dump images (special option). Recording is done with 24 bit resolution at a sampling rate of 44.1 kHz (audio stereo) to 384 kHz (IQ wideband).

Depending on the version, the RDR52 is equipped with different memory size. The maximum available memory size is displayed above the bar graph of the current utilization. Each device always has at least 2 Gbit (512 Mbyte) of memory. If more memory is installed, it can be activated by optional activation. You can always choose the doubling of the currently usable space:

2 Gbit (512 Mbyte) → 4 Gbit (1024 Mbyte) → 8 Gbit (2048 Mbyte) → ... to "Max available".

Usually, a few MBytes of the actively usable memory (to the right of the bar display) are missing compared to the unlocked memory size. The memory consists of so-called NAND flash memory. This type of memory may contain faulty parts that cannot be used. Their size is taken into account here.

On the left side of the dialog, a list of 11 files out of 256 possible files for recording appears. The list can be scrolled up and down with the tune knob. The filenames simply consist of their number in the list. After the number, the file size in the memory is displayed. Free slots are marked with "empty".

Recording is performed by tapping the virtual "Rec" button. Starting with 0 byte, the next free file slot is then filled with data. The amount of data is displayed continuously in the file field, as well as the total used storage capacity with a bar graph and as a numerical value.

If the recording length has reached the total memory capacity, it is automatically canceled. A limitation within the files does not exist. The entire memory capacity can be used for a single file, or distributed to multiple files.

A file can be played back using the "Play" button. The file in the topmost displayed slot will be played. The progress count is made by counting the amount of data from 0 byte and changing the color to green. The capacity indicator on the right side remains unchanged.

Tapping the "Stop" button aborts the recording or playback process. Tapping the "Hold" button interrupts or resumes the recording or playback process.

The sample rate button under "Rec" continuously switches the possible sample rates and recording modes:

- A 41k: Stereo audio with 40.96 kSps
- B 82k: IQ baseband with 81.92 kSps
- B 164k: IQ baseband with 163.84 kSps
- B 328k: IQ baseband with 327.68 kSps
- Screen: Image of the entire display with 800 x 480 pixels (special option)

There are some fundamental differences between audio recording or playback and baseband recording / playback. The type of recording is represented by "A" (audio) or "B" (baseband) in front of the file size.

- Audio files are always created directly from the data stream to the loudspeaker / headphones and are also routed directly there during playback. When recording, any change to the unit's setting (except volume) is recorded. On the other hand, changing the device setting (except volume) has no effect during playback.
- Baseband recordings are made directly from the ADC data after conversion to baseband (down-conversion). Most device settings do not affect this data, just the tuning and switching before the ADC (filter, attenuator ...). However, the choice of demodulator also has a great influence. For most demodulators, the reception data is **NOT** centered in the baseband! That is, the center of the baseband (frequency 0 Hz) does not correspond to the reception frequency. The baseband is more or less (depending on demodulator and filter bandwidth) unbalanced to 0 Hz. Only the FM-W demodulator works exactly symmetrical. When using the recordings for other purposes (transfer to PC) later, FM-W should be set during recording.
- When playing back the I / Q data in the RDR52, the same demodulator must be selected as when recording, otherwise the received signal will not be in the filter range of the demodulator. With time-based demodulators, the bandwidth selection also has an influence on the position of the baseband.
- The baseband is filtered before recording to prevent aliasing. Due to the limited steepness of the filters, the following alias-free bandwidths are achieved depending on the sample rate:
  - B 82k: 60 kHz
  - B 164k: 140 kHz
  - B 328k: 300 kHz

The filters of the FM-W demodulator are used for filtering. These are therefore adjusted accordingly.

The camera function enables display images ("Screen dumps") to be saved in the audio recorder. This function is a paid extension. After the function has been activated, the sample rate of the recording can be switched to "Screen" in the Recorder dialog. A screen dump is performed analogous to an audio recording by pressing the "Rec" button. The corresponding file is given the identifier "S" in the list.

The scanning of an image is carried out in the same way as scanning from a PC via the WiFi connection. However, a WiFi connection is not required for the screen dump. During the scanning process, operation of the device including the spectrum display is stopped and the still image is transferred to the recorder's flash memory. After successful saving, the RDR52 can be operated normally again. The saving process can also be started in the user interface via the Rec button. If you select "Screen" in the Recorder dialog, it is labeled "Dump".



The saved images cannot be displayed again on the RDR52 itself ("Play" has no function). They are intended for documentation purposes after transfer to a PC (see special function "File download").

Deleting files can be triggered by tapping the "Clear" key. The label "Actual and all following!" (Current file and all following in the list) will then be displayed inverted (red with yellow text). Tapping this label will irreversibly start the deletion process. If nothing is to be deleted, the process can be aborted with the "Escape" button. When deleting, the file slots are set to "empty" and the capacity display is updated.

**Caution!** Always all files displayed **AND** all in the list, possibly following up to slot 256, will be deleted! If only the last file(s) is to be deleted, the list must be scrolled to the point where the first file to be deleted is at the top. Individual files within the list can not be deleted selectively.

The "Erase" button deletes the complete memory. The information text indicates the duration since the deletion started. It can take up to 1 min. depending on the memory size.

The dialog can only be closed by tapping the "Escape" button. Closing is not possible when recording or playback is in progress or when a deletion has been initiated.

## 7. Special features

All previously described instrument settings and functions are the appropriate to the use of the RDR52 and will be required more or less often. However, some functions are rarely or never necessary. These are described below.

The variety of possible settings and operating modes of the RDR52 may lead to incomprehensible settings. Switching the device off and on again does not help in this case: All device settings are saved; after switching on, the RDR52 is in exactly the same operating state as when it was switched off (Exception: Dialogs are closed), even after a longer operating pause without power supply.

There are several possibilities to set the device to a known operating state:

- The "Undo" function.
- Resetting to a basic state, called "factory setting" ("Defaults").
- The complete deletion of almost all software in the device and the re-saving of other (new) software ("Software Update").

### 7.1 Undo function

Use this function if you have performed only a few operations that have led to an unsatisfactory or confusing setting state of the device. You can return the setting state of the device to one of the last maximum of 28 operating states. Note the current status of the undo level, which always appears in the lower right corner of the user interface:

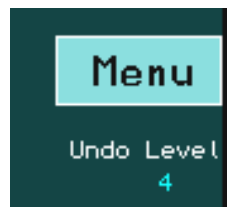

**The device is currently in state "4".**

Now try to define a certain number of operating steps from where you want to undo the settings and subtract this number from the current state. Subtract this number from the displayed undo state, calculating a possible "underflow" to 0 or negative values as a count back to the highest possible value of 28:

*Example:* Current state 4, desired return of the device setting by 5 operating steps:

$$4 - 5 = -1 \rightarrow (0 \text{ equals } 28) \rightarrow 28 - 1 = 27.$$

Open the System dialog. Select the setting "Undo back to level:" and set it to the desired undo state (as per example "27"). Close the dialog by tapping the "OK" button. The device is set to the state that existed when the undo state "27" was last seen in the display (i.e. before 5 operating steps).

*Note:* The undo value is always counted when buttons are pressed (the state of the device is saved again). At any time, you can completely store the device setting by tapping any non-active setting. Remember or write down the displayed undo state if you think you possibly want to reverse the next device setting.

*Note:* At switch-on the setting of the device is restored to the level displayed when switching it off. If you make a note of the displayed value immediately after switching on, you can return to this power-on state up to the undo-system overflow (i.e. the automatic reuse of this space).

### 7.2 Factory setting

Slot 0 of the Undo function ("System" dialog) always consists of a basic setting that cannot be deleted (factory setting, "Defaults"). By calling this function, the device is set to a basic state with defined set values (e.g. frequency 81.92 kHz, demodulator SYNC, shift 0 etc.).

*Note:* You can also use the manually allocated memory slots (see "Memory" dialog) to load defined settings that you have stored yourself in a specific slot. These memory slots are not changed by the undo function or the factory setting.

## 7.3 Software Upload

The RDR52 allows a change of its functionality by the programmed software ("Firmware"). It can be re-loaded at any time by connection to a personal computer (PC). The firmware determines not only the programs of microprocessors commonly referred to as "software", but also the existence of specific units such as processors or interfaces within the device (so-called "Softcores") by the configuration files of the programmable logic circuits used ("FPGA" = Field Programmable Gate Array) as a whole.

The connection with a computer is established via WLAN ("WiFi network", see "WiFi" dialog). A connection to the RDR52 always requires the beforehand login of the computer into the active access point of the RDR52. This process depends on the computer and its operating system. The RDR52 supports DNS with automatic assignment of a network address to the connecting computer.

The following describes the procedure for a typical installation of Windows 7 or 10 on a personal computer / notebook (recommended computer for software update). The computer must have a wireless module installed or plugged in (i.e. USB module). The operating system then sets up appropriate software to detect active networks ("Wi-Fi network", "access point", "hot spot" or similar wording) and to connect with them. The found networks are displayed in a list as shown here:

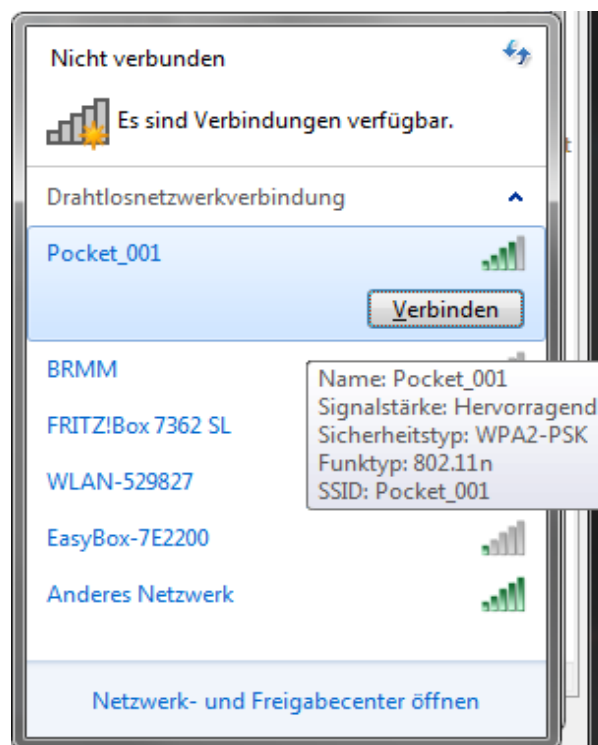

Select the network with the name set in the RDR52 (SSID) and start a connection. The first time you login you usually will be asked for the encryption and the appropriate key (password / key ...). Select AES (WPA2) and enter the 10-digit Passkey as set / displayed in the RDR52. Thereafter, the computer should have established a connection (display "Connected" or similar). In case of errors, consult the operating instructions of the computer / operating system and check whether the RDR52 is still operating correctly (possibly switch off the access point and switch it on again after a short waiting time, reconnect the PC).

Once the computer is connected to the RDR52, a service software on the PC can perform all desired functions. The program "RDR51E.EXE" (website) is available for the RDR52. Start the program and after a few searches and possible messages, its user interface will appear as shown below.

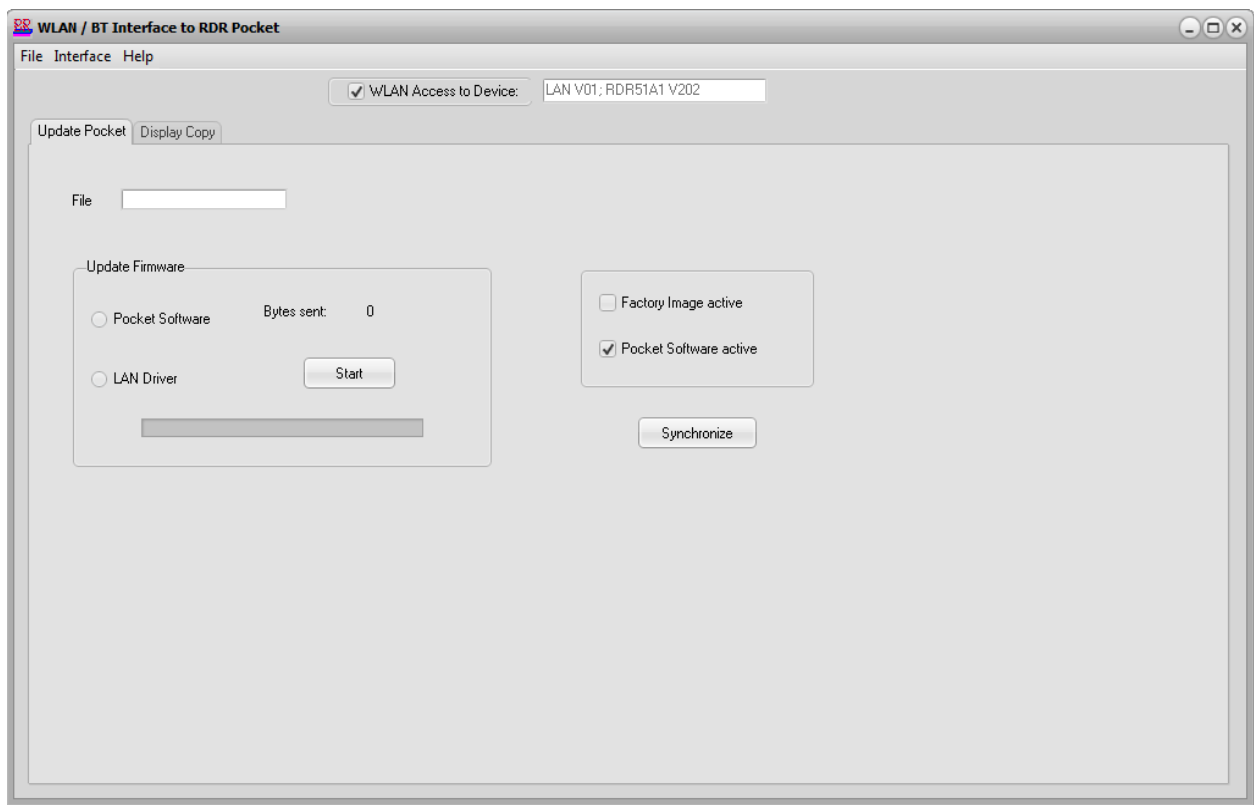

If there is no WLAN connection, the message "Access Point not found!" appears. In this case, check whether the PC is correctly logged in (connected) and possibly repeat the process. If the connection is poor (unfavorable channel with a lot of interference) or the signal is weak (long distance between PC and RDR52), the connection occasionally breaks down.

If the program is already running and the RDR52 is restarted or the connection is re-established, access may be re-established via the menu Interface → Find WLAN Connection. Of course, you must always first log the computer itself into the RDR52 network!

A correct data connection from the service program to the RDR52 is only available if the version numbers of the RDR52 appear in the field behind "WLAN Access to Device:" and a tick can be seen in the field above the "Synchronize" button. If the version numbers have been recognized, but no tick is visible, the "Synchronize" button can establish the connection. It may also be necessary to quit and restart the program in order to detect a newly established network connection.

**Caution!** Each time the RDR52 is switched off, the WiFi connection is interrupted. The computer will only log in automatically, if so provided in the operating system. Set this appropriately or re-log the computer manually each time!

2 different units of the RDR52 can be updated with new software:

- The FPGA of the RDR52 with its configuration of all circuits and the user interface.
- The software of the network processor (LAN driver).

The software to be loaded is selected on the left side of the program in the field "Update Firmware". **Be sure to make the right choice and open the appropriate files as described below!**

The software of the RDR52 always has the name extension ".RPD", e.g. "RDR52DV212.RPD". Firmware updates in the form of RPD files are available on the manufacturer's website. To load an RPD file into the RDR52, proceed as follows (assuming correct connection):

- Select the item "Pocket Software".
- Open the desired file via the menu item "File" → "File Open" (".RPD" is always the default). The file name must now be displayed in the "File" field.
- Click on the "Start" button. The "Bytes sent" display must now count the number of bytes transferred consecutively.
- At the end of the transmission, a window appears indicating the successful transmission.
- For errors, a message window appears with a note on the error (e.g. "Device not responding"). Check the WLAN connection and re-establish it if necessary.

- If no upload is possible after several attempts, stop the service program, switch the RDR52 off and on again and repeat the entire procedure.

**Caution!** Never switch off the device or the PC during the upload process and never disconnect the WLAN connection!

*Note:* After a successful upload (message in the PC program will appear) the RDR52 must be switched off and on again so that the new software is started. Check the successful start by means of the version number displayed in the user interface at the bottom right. It must match the number in the file name. If a lower version number is displayed instead, upload and / or restart were unsuccessful. Repeat the upload and pay attention to loading the correct file.

An update of the network driver is only necessary in rare cases. The process is the same as the previously described upload of the RDR52 software. However, select the item "LAN Driver" this time and open the corresponding file. The driver's extension is always ".BIN". In order for the driver to be uploaded into the RDR52, this process must first be enabled in the WiFi dialog with the item "**Driver Update**" and its corresponding set value "On" (see there). **As long as the activation is set to "On" or the update is running, the WiFi dialog must not be closed or anything be adjusted on the RDR52!** Now click on "Start".

Updating the driver is performed in 2 steps:

- Upload of the file as with the RDR52 software. The file transfer is displayed instead of "On" in the WiFi dialog as a counter of the received data blocks. After a message displayed on the PC about the end of the transmission (or an error message), the WLAN connection is aborted. The program RDR51E.EXE must be closed.

- The RDR52 programs the received data into the memory of the network processor. The process is again indicated by counting the data blocks. After programming has finished, the message "OK" or "Fail" appears. Now set this display by tapping (should still be active from the activation in the "On" state, during this time nothing else may be operated on the RDR52!) on "Off". The access point must then be switched off ("Mode" setting). Close the WiFi dialog afterwards

The updated driver is now loaded each time the access point is powered up. A check of the version number is possible when establishing the connection with a PC and starting the service program RDR51E.EXE (see above).

**Caution!** If new LAN drivers are available, they must always be loaded before any new RDR52 software!

Older software is available on the data mediums supplied or on the manufacturer's website. If not included / no longer available, please contact the supplier of the device.

### Summary of the update process.

- Download the RPD file suitable for your device from the internet ([www.Reuter-Elektronik.com](http://www.Reuter-Elektronik.com)).
- Download the network driver RDR52WLANV54.BIN (or higher) from the Internet.
- Download the connection software RDR51E.EXE (or higher) from the Internet.
- Turn on the RDR52 (connect stable power supply and WiFi antenna) and activate the access point.
- Deactivate any data connection between the Windows PC and other devices (router / Internet) or switch off the connected devices.
- Log the PC into the RDR52 (follow the instructions in the section "Software Upload").
- Start RDR51E.EXE and check the stable connection (check display of version numbers, execution of a display scan).

Only if the LAN driver is to be reloaded as well:

- Activate "LAN-Driver" and open the file RDRWLANV05.
- Activate the clearance of the driver update in the WiFi dialog of the RDR52.
- Transfer the file by pressing Start.
- The update is finished when "OK!" is displayed in the clearance field in the RDR52.
- Switch the access point off and then on again after a few seconds.
- If necessary, log in the PC again and activate and test the connection in RDR51E.EXE again (menu "Interface" and button "Synchronize", or restart the program).

- Activate "Pocket Software" and open the RPD file.
- Transfer the file by pressing Start.
- The update is finished when the message window indicating the end of the transfer appears.
- Switch off the RDR52 and switch it on again after a few seconds.
- The small red version indicator at the bottom right of the display must show V21x or V41x (C4 only) (x = digit corresponding to current version in the name of the RPD file).
- If the display is incorrect (older version still active) or other errors during the transfer, the process must be repeated completely. Any successfully loaded LAN drivers do not have to be reloaded before the software update.

## 7.4 Display Copy

The RDR52 permits reading data from the device via the WiFi connection. The output of the display content ("print function") and the recorder memory can be read. Saving and printing of display content is often desirable to document reception conditions and measurement results. This function is also available in the service program. Simply click on the tab "Display Copy".

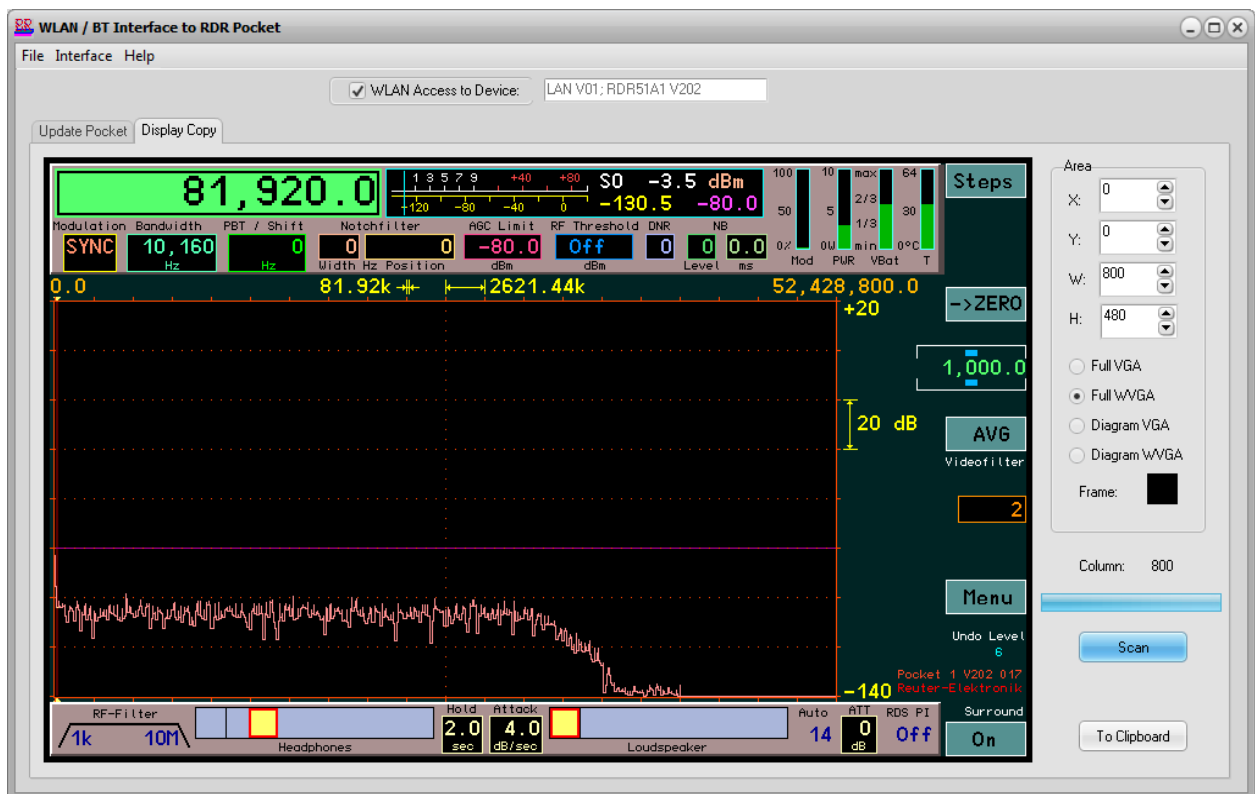

You can select any section of the screen to be copied and transferred to the PC. Select it using the pixel coordinates of the upper left corner of the area (X and Y, starting with 0 from top left). Set the desired width (W) and height (H) of the section to copy one. If useful select a suitable preset setting and the color of the background (click on the color box behind "Frame"). The visible blank image is adjusted according to your choice in size and color.

Start the copy process by clicking the button "Scan". The screen content of the unit's display is now transmitted column by column from the left and afterwards appears in the image. In this case, a frame around the transferred image is maintained by each 5 pixels after the final scan on all sides. During the transmission it is not possible to control the RDR52 and no screen updates occur (spectrum / waterfall). In the readout "Column" the current progress of the transmission can be seen. It ends with a success message or aborts with an error message. If necessary, restart the scan after aborting. Wait until the RDR52 reacts to input again!

**Caution!** You should use a PC with enough processing power and configure it that no application software (close running programs) or operating system is blocking the data transfer. If the PC is not able to process the data sent by the RDR52 in time, the scan will abort. The transmission also aborts easily with poor Wi-Fi connection quality (low data rate).

The image can be saved in BMP format for further processing via the "File" menu → "File Save", or transferred directly to the Windows clipboard by clicking the "To Clipboard" button.



*Note:* A good method to check the WiFi connection before a possible software update is making a display scan! Smooth data transfer without prolonged stalling indicates a stable connection.

## 7.5 File download

The recorder files stored in the RDR52 can be transferred to a computer via WiFi. The "Recorder" tab in the RDR51E.EXE service program is used for this purpose.

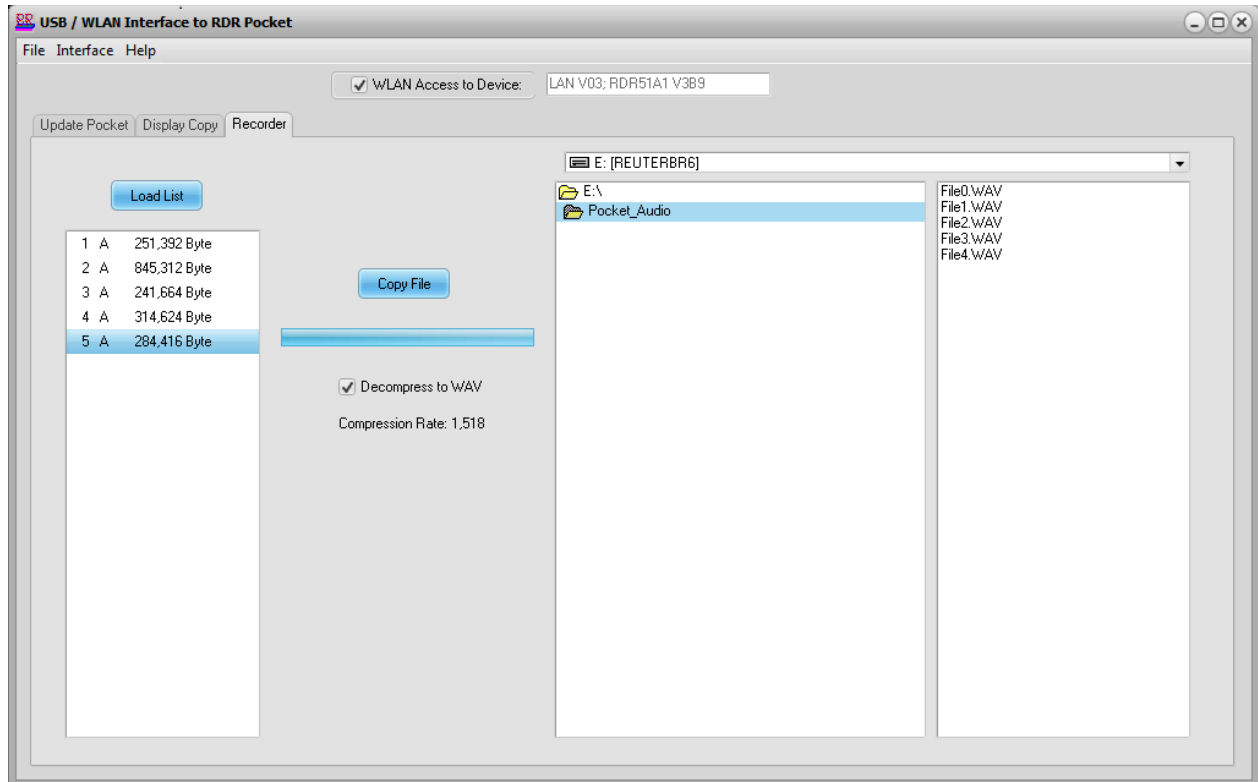

First of all, the RDR52's list of recorder files must be checked by clicking on "Load List". It appears in the left window similar to how it is displayed in the RDR52's Recorder dialog. From this list, one file can now be selected. Multiple files can not be selected at the same time. Clicking on "Copy File" transfers the file from the RDR52 into the PC. It is stored on the drive and in the directory selected by the program window on the right. The file's name results from the word "File" plus the number in the RDR52 minus one (starting with zero instead of one as in the RDR52).

The RDR52's files are stored in a special format that only the RDR52 itself can use. By selecting the option "Decompress to Wave" (default), the data can be saved in the Windows compatible WAV format (uncompressed audio data). If the transferred files are audio recordings (defined by the corresponding setting in the RDR52 when recording), the files can be played and listened to with the preferred software on the PC.

Baseband mode recordings ("B" after the file number) are not "real" audio files. They contain the RDR52's baseband data according to the selected settings during recording with the associated sample rate. "Real" audio data ("A" after the file number) is always stored at 40.96 kSp as a stereo stream. The baseband data can only be displayed and played back with a suitable software ("SDR program").

The files can also be stored in the RDR52's original format (deselect "Decompress to Wave"). By using this method, the files can be transferred faster to the PC and less storage space is needed. Files with the extension "HEX" are created. These contain compressed data that can only be converted to WAV audio or baseband data using suitable software (optional).

Images and audio files stored in the recorder can be transferred. When you select an image file (code "S") the decompression button changes to "Decompress to BMP". After the transfer, the image is visible **on the "Display Copy" tab** and can be transferred to the clipboard or saved as a BMP file. Without decompression, a file is created with the raw data (pixels as byte values in columns from top left to bottom right).

## 7.6 DAB Reception

The RDR52 is equipped with an independent receiver module, which allows the reception of DAB / DAB + broadcasts. No signal processing of the RDR52 is used in the process, only the audio output and the operation via the RDR52 hardware. Accordingly, almost all functions of the RDR52 are disabled, whether spectrum-based or time-based.

***Caution!*** DAB reception does not correspond to the main function of the RDR5x (reception of analog modulations) and is only supported if it can be implemented with the RDR52 hardware. The main application of the RDR52 lies in the reception of analog modulations, not the reception of digital data streams with PC compatible formats! These are also subject to licensing constraints and do not represent free broadcasting in the opinion of the developers of the RDR52!

The DAB module is located on the FM expansion board C2 for the first expansion slot in the signal path behind the first pre-filter / preamplifier. It thus benefits from the low input noise of the RDR52 and allows good reception. **However, the prerequisite is always the connection of a suitable antenna.** A simple telescopic antenna or similar usually allows the reception of a few low quality stations.

DAB or DAB + are digital modulation types. The information is transmitted in the form of bits which are coded, compressed, interleaved and modulated in a variety of ways. The reception of such transmission types differs fundamentally from, for example, AM or FM transmissions. The RDR52 has thus (unfortunately) no influence on the quality of the received broadcasts (except in the LF range, which is designed with 24 bit / 81.92 kHz with very high quality in mind).

To receive a DAB (+) station, follow these steps:

- Switch the reception range in the Setup dialog (value "Filter bandpass") to 174 - 240 MHz. Alternatively, tune the frequency from the value 156 MHz to higher values (filter on automatic), or enter a frequency in the range 174 - 240 MHz directly, or select a slot with a stored DAB program within the Memory dialog or tap on the button "Discover DAB".
- A message appears in the frequency display: "Search DAB...". You can not receive DAB stations "just like that" indiscriminately. The receiver module first has to compile all sorts of program data. For this purpose, it searches the entire frequency range (band III) for active stations and their program content (transmitted data streams).
- The result is a list of receivable stations and their program content. The frequency display shows the number of receivable programs. If this list contains at least one program, the first program in the list is selected for reception. Otherwise, the message "DAB Failed!" appears.
- No station frequency is displayed, only the program number in the list. There is no frequency tuning. Only the program list can be scrolled with the tune knob. A maximum of 256 programs are possible. If the number is lower, the corresponding places in the list will be empty.
- A program can be selected by tapping the list entry. The list entry is then surrounded by a yellow frame. To the right of the list are some more information about the selected program.

Note: When switching on the DAB mode via one of the aforementioned methods, a complete DAB scan is only performed if no scan has ever been performed since the device was switched on (first time the DAB module was switched on), or if the button "Discover DAB" was selected in the Memory dialog. If a scan has already been performed and DAB reception has been terminated in the meantime (e.g. by switching to an FM broadcast station), it is possible to switch back to DAB immediately by entering a frequency in the DAB range or selecting a DAB program in a memory slot.

The DAB program list scanned when first switched on may change during operation (whether in, or not in DAB mode) if reception conditions change (mobile operation, fluctuating reception conditions). The display in the RDR52 then no longer matches the actual receivable list (tapping a program returns a completely different program or no program at all). In this case, a new scan must be performed (switch off / on the device or tap button "Discover DAB").



Two further requirements must be met to hear it: For this 2 further requirements must be met:

- The program must transmit an audio stream. Programs with data-only services are not audible (display at the bottom left of the program line).
- The reception quality must be sufficient to be able to demodulate, decode and decompress the program ("RSSI" indicator bar at least 1/3 green).

Especially the last case can cause unpredictable dropouts, fragmentations or total failure of the program due to fluctuating reception conditions. Borderline conditions result in peculiar distortions similar to the audio "quality" of mobile phones in poor connection. Therefore, ensure stable reception with a good antenna and by locating the RDR52 in a low-noise environment.

The 2-line entries in the program list contain various information. These are (order from upper left row to lower right row):

- Channel number from 5A to 13F.
- Name of the ensemble (the "multiplex", the summary of various programs on a station).
- Program type (same name as RDS program type on FM).
- Service type: DAB, DAB+, DATA or DMB. Only DAB and DAB+ are receivable.
- Program name.
- Service component number.
- Service component ID.
- Service ID.
- Ensemble ID.

To the right of the list, the following information is available, each updated for the selected program:

- Sample rate of the audio signal: 24, 32 or 48 kHz.
- Bit rate of the compressed data stream: The higher the value, the lower the compression factor / higher the audio quality.
- Quality / signal strength (RSSI) of the data stream from 0 - 100%: The display is based on an internal calculation of the bit error rate and measurement of the reception level. 100% quality = no errors, 0% = no data decodable. Values below approx. 60% result in dropouts in the audio signal. Below about 30%, nothing is audible.
- MOT 1 / 2: Type of multimedia data sent. Possible are: Slide Show (SLS), BWS, TPEG, EPG, DGPS, TMC, Java, DMB, Push(Data), Journal(ine) or unknown.

To evaluate the MOT data, additional decoders are required. Depending on the software version or type and equipment of the RDR52, these can be supplied or additionally installed. Depending on the MOT data type, the decoded data will appear in the window to the right of the DAB dialog (for example, as an image

or as a text). A slideshow decoder is always installed.

The slideshow images can be sent in various PC-compatible formats (compressed JPG and PNG). Unfortunately, this data requires a corresponding decoder (PC software) and display units (min. QVGA monitor or newer formats such as HD). Due to the lack of a PC-compatible processor including the usual memory, decoding takes considerable demands on the RDR52's resources. Therefore, the following restrictions apply:

- Only JPG with baseline DCT (compression process) and chrominance sampling rates of 4:4:4, 4:4:0, 4:2:2 and 4:2:0 can be decoded. These formats are used by many programs. For example, almost all of the programs in the "Bundes-Mux" 5C transmit such images.
- PNG images are decodable if not too large. Depending on the memory load of the graphics controller and the operating microcontroller, image data that is too large is cut off (image appears only partially) or will not be displayed at all. Devices with built-in transmitter (module C3 or C4) do not decode PNG data.
- The image is built up line by line with the old image being overwritten by a new one from top to bottom.
- No saving of image content. The current picture content is lost when performing different operations (e.g. calling up dialogs).
- The decoding only takes place when there are no other important tasks to be performed. Image data can be lost during many operating processes with a high load on the microcontroller (e.g. scrolling the program list). Then the image appears distorted or completely corrupted.
- No error checking or correction of the received image data. Reception errors lead to distorted or completely corrupted image content.
- Only 256 colors can be displayed.

The images are retained even after the program has been switched until data is received from the newly selected program or operations delete the image content.

Below the MOT window, the program text of the selected program is displayed, if available (transmitted).

As long as the RDR52 is operated in DAB mode, not all functions of the RDR52 are available. However, most of the dialogs can be opened and operated via the "Menu" virtual button. The Microphone dialog displays the spectrum of the DAB audio signal.

Tapping the frequency display (DAB: display of the program number) opens the Memory dialog as usual. DAB programs can be saved or called like other memory entries. No frequency is stored for a DAB program, only the name of the program in the list.

## 8. Specifications

Frequency range (version C1):	0 - 30 MHz, 50 - 71 MHz
Frequency range (with module C2):	0 - 30 MHz, 50 - 71 MHz, 87.0 MHz - 110.0 MHz, 130 - 156 MHz, 174 – 240 MHz (only DAB reception)
Frequency adjustment:	Rotary knob with increments of 0.5 Hz to 999.999.5 Hz, direct input via virtual keyboard, via touchscreen
Frequency deviation internal oscillator:	<± 5 ppm min after 10 min, internal manual calibration
At active GPS with at least 7 satellites:	<± 1 Hz on oscillator clock 83.88608 MHz
Input resistance BNC connectors:	50 ohms
Max. input level:	<= 71 MHz: -6 dBm, with attenuator: up to +13 dBm
Max. processable input level:	> 71 MHz: -30 dBm, with attenuator: up to +1 dBm
Level of inaccuracy:	<= ± 3 dB
Inherent noise (MDS) <= 71 MHz:	<= 163 dBm/Hz
Inherent noise (MDS) >= 87.0 MHz <130 MHz:	<= 170 dBm/Hz
Inherent noise (MDS) >= 130 MHz:	<= 168 dBm/Hz
Intermodulation distortion <= 71 MHz:	IMA3 >= 84 dBc, 2x -14 dBm at 10 MHz
Intermodulation distortion > 71 MHz: (each approx. 2 dB below ADC limitation)	IMA3 >= 64 dBc, 2x -36 dBm at 100 MHz
Filter bandwidth (SBSP):	10 Hz - 20.4 kHz depending on settings
Filter bandwidth (time-based):	125 Hz - 20 kHz depending on settings
Stereo crosstalk:	>= 80 dB, 0 ... 15 kHz, bandwidth 300 kHz HQ
Audio output:	Headphone: Stereo DAC 24 bit, max. 1.5 Vrms on 32 ohm Loudspeakers: D amplifier, max. 2x 0.7 W to 8 ohm
Memory slots:	28 for undo function, 199 freely assignable
Display:	TFT 4.3" (109 mm) diagonal, WVGA 800 x 480 pixels, 256 colors, brightness max. 250 cd/m <sup>2</sup> , viewing angle (horizontal/vertical) 130°/120°, contrast (black/white) 400, response time 30 ms, resistive touchscreen
Connectors:	BNC socket for receiving antennas, SMA socket for GPS antenna, SMA socket for WLAN antenna, 3.5 mm stereo jack sockets for headphones, microphone and Morse key, hollow pin socket 2.5 mm pin DC input
Power supply:	9 V ... 14.5 V DC max. 0.8 A
Size (width / height / depth without connectors):	189 mm / 108 mm / 105 mm
Weight:	max. approx. 0.8 kg, depending on variant / equipment
Operating conditions:	0 ... +35 °C ambient temperature, <=99 % rel. Humidity non-condensing, IP 40, Pollution class 2
Compliance:	CE according to DIN EN 55013, EN 55020, EN 60065 (Consumer electronics and related equipment), RoHS / WEEE Directive, ear-Reg. 27676700

All specifications are subject to design changes!

## 9. Brief introduction to SBSP

The SBSP "Spectrum Based Signal Processing" is a novel principle in the processing of radio signals. This principle has long been known in measurement tech as well as commercial, military and space applications and is used for various applications, for example:

- Spectrum analyzers
- Digital telecommunications networks
- Sonar equipment
- Radio astronomy
- Broadband radio monitoring

Furthermore, is also used in the private sector in the form of SDRs "Software Defined Receiver". In this case, a PC attachment receives the RF signals and, where appropriate, converts them into digital signals and forwards them to a PC, or feeds the analog signals into the sound card of the PC. Software running on the PC then takes over the function of the receiver by "simulating" the usual analogue processing stages as a program sequence on one (or more) powerful processors.

All these applications share the following characteristics (with rare exceptions):

- Using the FFT algorithm to transform the time-based data ("oscillogram") into frequency-based data ("spectrogram").
- Use of spectrograms only for measurements and visual representations.
- No use of the spectrograms to directly process the modulated information (filtering, demodulation, audio generation).

The latter does not apply to special modulation processes (e.g., digital voice transmission in telecommunication networks) which have been developed specifically for the use of the FFT algorithm.

All other common "analogue" modulation types like AM, SSB or FM are not processed spectrum-based. The reasons for this are, among others:

- High effort for simultaneous application in measurement / image display and signal processing.
- Missing software (programs to imitate the analog principles are freely available, proprietary software development for SBSP is complicated, time-consuming and expensive).
- **The FFT algorithm is NOT SUITED for good results.**

Since the FFT is otherwise used everywhere, the last statement should be briefly clarified. "FFT" is a binary calculation rule ("algorithm") optimized for the digital execution in clocked systems ("processor"), which performs the mathematical process of the Fourier transformation of a signal of specific length (duration). The execution of this "analogue" transformation (consisting of a theoretically infinite variety of signal states) based on discrete (finite amount) digital samples of the signal (the samples from the ADC) leads to significant limitations in the achievable results.

This is similar(!) to the well-known Nyquist theorem: A signal can only be uniquely (re)produced if its bandwidth is less than half the sampling frequency. For the FFT one could say: It is only possible to calculate a unique spectrum from a certain number of samples whose resolution reaches at most the reciprocal of the signal duration (number of samples times sampling period). For example, to get a spectrum with a resolution of 1 Hz (the distance of the spectral lines, i.e. the smallest possible separability of two frequencies), a signal duration of at least 1 s is necessary. Or in other words: At 1 Hz resolution, you can only get a unique spectrum once per second.

In addition, there are further limitations (disturbing artifacts) such as side resonances or level errors of the spectral lines ("picket fence effect"). All this makes the FFT unusable for direct signal processing of analogue modulations. Experiments have shown that for a usable signal quality resolutions of the spectra of at least 10 Hz are required. Experienced ears can hear even 1 Hz difference at higher frequencies. On the other hand, (apparently) continuous tone generation requires a spectral rate of at least 50 S/s (spectra per second). That compares most fittingly with image processing. There, too, the eye sees individual images only at about 50 Hz as a continuous movement.

In order to be able to use the advantages of SBSP nevertheless, another algorithm than the FFT must be used. A scalable time-frequency transform is used in the RDR52, which operates 4 times faster than the FFT in the RDR receivers. In the example, error-free spectra with 1 Hz resolution could be generated from a signal duration of 0.25 s. Or 10 Hz resolution with 40 S/s, 20 Hz with 80 S/s etc. This roughly corresponds to the requirements for a sufficient signal quality.

Thus, this algorithm can be used for signal processing (filtering, demodulation) in devices that do not require Hi-Fi audio quality (hand-held radios, amateur radios, simple AM radio receivers, etc.). It offers enormous advantages in terms of selectivity and flexibility (fine-tuned and far-reaching parameter adjustability and easy implementation of additional functions such as notch and noise filters).

However, it is not (yet) applicable for direct signal processing of FM-modulated signals. This would require much higher spectral rates with much higher resolution. An issue for the future. Filtering and FM demodulation are therefore performed in the usual time domain on the basis of individual samples in the RDR52.

However, the SBSP can also be used advantageously in the stereo decoder and in the RDS decoder. Here, the most popular use case is the processing of narrowband signals without high data rates (with the exception of the difference signal).

### **Stereo decoder**

The task of the stereo decoder is actually not decoding, but a demodulation. The difference signal present in the MPX signal in the form of a two-sideband modulation with suppressed carrier at 38 kHz must be demodulated and offset with the sum signal. This then results in the left and right audio channels.

The main problem is the absence of the carrier (called "subcarrier") for AM demodulation of the difference signal. Instead, the so-called pilot tone is contained in the MPX signal (always clearly visible in the RDR52's MPX spectrogram). Its frequency is exactly half of that of the necessary subcarrier and its phase (time of zero crossings) corresponds exactly to that of the necessary subcarrier. This can therefore be generated ("regenerated") from the pilot tone.

The exact regeneration of the subcarrier in terms of frequency, phase and amplitude is essential for the accuracy of the difference signal's demodulation and thus the quality of the L / R stereo signal. (Of course, the exactness of the demodulation and the difference signal itself, too. The latter is strongly dependent on the filter and FM demodulator.)

All current regeneration methods produce more or less strong errors of the 3 parameters. They mainly result from having to work on different frequencies (19 kHz → 38 kHz, mixing to 0 Hz) and using different filters (bandpass, lowpass). These introduce deviating phase and amplitude responses. A digitally operating system can avoid some of these errors. Above all, they are constant and predictable and therefore can be stably corrected by compensations.

The RDR52's SBSP operation allows differential signal demodulation without any artificial regeneration of a carrier signal. Only the original pilot tone is required. The pilot tone can advantageously be taken out of the SBSP in extremely narrow band and with very low noise. It represents "only" a single spectral line that should be used. Everything else around it is simply omitted (numerical selection principle instead of filter specifications).

Furthermore, the "spectral line" pilot tone is no longer a specific frequency, but a so-called IQ signal (mathematical signal in the form of complex numbers) with the target frequency 0 Hz. Also, the difference signal can be taken from the SBSP so that its center is around 0 Hz. (In contrast to real signals, IQ signals can represent negative frequencies, so the lower sideband is negative, the upper positive is around zero.) Thus, both signals match without subcarrier generation and are already demodulated. Only the phase synchronization remains, which is performed as a simple phase shift of the differential signal depending on the phase of the pilot tone.

The amplitudes also match exactly due to the relative level accuracy of the SBSP of the RDR52 ( $\pm 0.1$  dB) and to the sum signal. A correction of the absolute values can be carried out easily and stably. This makes channel separations over 80 dB achievable. Incidentally, at this point, the base width adjustment is made. Only the level of the difference signal is changed from 0 to 200%.

### **RDS Decoder**

The RDS decoder operates similar to the stereo decoder in its first stages. Again, a demodulation ("mix") with a non-existent subcarrier is necessary again, this time at 52 kHz. As with the stereo decoder, the spectral line of the pilot tone is used immediately and the RDS sidebands are taken from the SBSP in the correct frequency, phase and amplitude. The subsequent stages correspond to the usual decoding of the RDS data with error correction.

The RDR52's RDS decoder allows one wrong bit per block. This enables a fast response of the decoder (DX operation). However, occasionally erroneous characters appear at a too low signal-to-noise ratio. The RDS dialog provides information about the current error rate.

A disadvantage of the SBSP with the RDS decoder is the necessary availability of the pilot tone in the MPX spectrum. RDS signals from stations that do not transmit a pilot tone (i.e. that only transmit in mono) can not be demodulated. However, these are very rare cases.



# 10. Transmitter

The RDR52 can be equipped with a radio transmitter. It is located on module C3 of the second RDR52 slot. It contains a complete transmitter for 11 amateur radio bands from 160 m to 6 m including a power output stage with a maximum output power (PEP) of 5 W.

## 10.1 Overview

Like its receiver, the RDR52's transmitter operates all-digital using partially radical new functional principles. While these provide the receiver with a newly developed time-frequency transformation without FFT for outstanding reception, the principle of digital polar coordinate modulation is used in the transmitter.

Seen just for the power amplifier (PA), this corresponds to the familiar "envelope" method. Here, a Class C or E / F amplifier is operating (not linear) with a modulated power supply, where the current peak corresponds to the envelope of the generated signal. The amplifier must be phase modulated. An output filter suppresses the harmonics of the nonlinear amplifier. The necessary signals for the modulation of the supply voltage and the phase modulation of the amplifier are extracted in other devices from an analog signal (SDR conventional transmitter or transmitter with digital to analog converter).

In the RDR52 the generation and modulation of all signals is basically done on the level of phase and magnitude information (polar coordinates). Therefore, all the signals required for the power amplifiers are available from the beginning, thus no D / A converter is necessary. The signals have a high accuracy and thus allow good characteristics of modulation and signal quality of the high-frequency transmission signal.

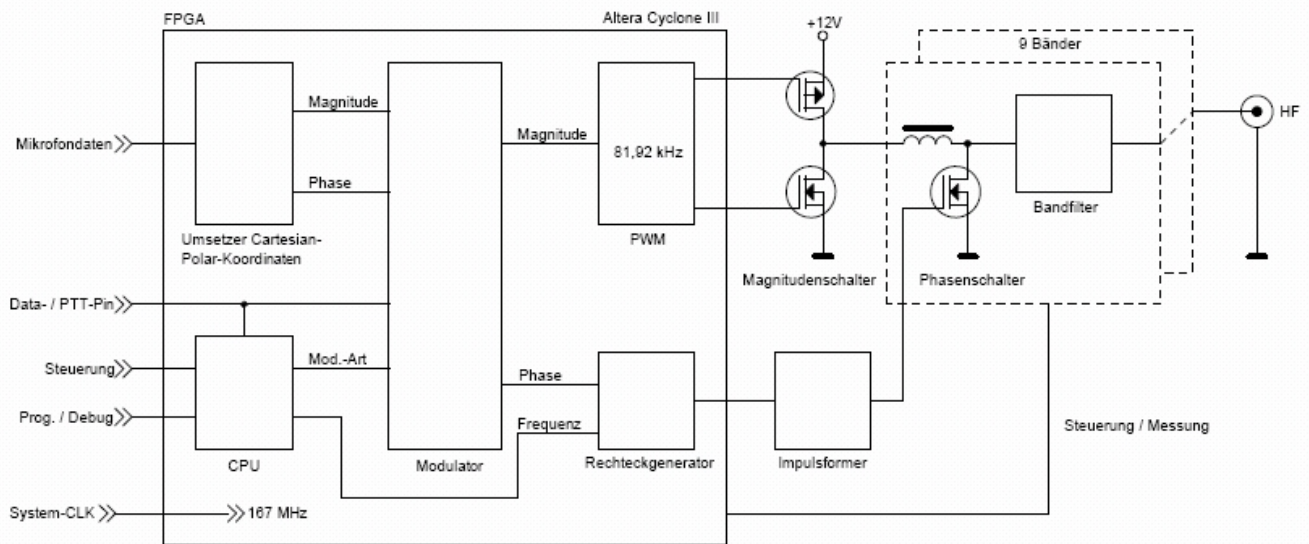

**Block diagram of the polar transmitter**

The statement: "no D / A converter" is of course not entirely accurate. Ultimately, however, a sinusoidal, analog transmit signal with the respective modulation is generated. The transformation of the rectangular, digital control signals into the analog transmission signal is done at polar transmitter but not by a semiconductor device with subsequent amplification. Rather, the powerful high-frequency oscillation occurs directly inside the reactance of the output filter. Here a relatively high reactive power oscillates, controlled by phase and magnitude switches whose filtered-out real part (with some reactive component, depending on the alignment) creates the analog transmission signal.

The magnitude switch for the modulation of the envelope is present only once, while there are separate phase switches and output filters for each band. However, 17 m and 15 m band, and 12 m and 10 m band share one waveform with another. The band switching or release of the modulation is done electronically at the sender without the use of a relay. Exception is the transmit / receive switching to disconnect the RX during transmission (silent reed relay).

For the achievable signal quality the properties of the switch and filter components and the accuracy of the control signals are of crucial importance. Here are some examples of the resolution obtained with regard to bit-width and frequency / time resolution:

- Magnitude and phase: 18-bit with kSps 81.92
- PWM Clock: 334 MHz + DDR (=double data rate) -> 13 bit resolution, 1.5 ns accuracy of the

- control signals of the magnitude switch
- Square wave generator frequency setting: 0.625 Hz resolution, 6 ns time resolution of the flanks
- Pulse shaper: Increasing the time resolution for both flanks to 10 ps accuracy of the control signal for the phase switch.
- Phase switch: ZVS switch (=zero voltage switching) for up to 50 VA reactive power.

The highly accurate and jitter-free adjustment of both flanks of the control pulse of the phase switch is essential for the CW quality of the generated signal. The achieved 10 ps correspond at a 40ns signal period approximately a resolution of 12 bits. The quality of the output signal resembles the one coming from a DDS generators with similar DAC resolution, their spurious and noise spectrum are quite similar.

The characteristics of analog components, including the switches and the accurate reproduction of the envelope are critical factors for the resulting intermodulation products in AM, SSB and DSB.

A big advantage of the "polar method" is the high possible efficiency (active elements only in switching mode). In this regard, the RDR52's transmitter is optimized for maximum effectiveness. In normal SSB or CW operation, the device heats up little more than 5 W PEP, even when it is receiving. For CW continuous wave or FM, however, maximum power is not permanently possible.

The transmitter has its own output (BNC) for controlling an antenna or an external PA. It does not have a transmit / receive switch. It must be implemented externally on the antenna (or use of separate receiving antennas) or is usually present in a PA.

## 10.2 Specifications

Frequency ranges (band number):

160 m band (No. 1): 1.81 ... 2.0 MHz  
 80 m band (No. 2): 3.5 ... 3.8 MHz  
 60 m band (Nr. 10): 5.250 ... 5.450 MHz  
 40 m band (No. 3): 7.0 ... 7.2 MHz  
 30 m band (No. 4): 10.1 ... 10.15 MHz  
 20 m band (No. 5): 14.0 ... 14.35 MHz  
 17 m band (No. 6): 18.068 ... 18.168 MHz  
 15 m band (No. 7): 21.0 ... 21.45 MHz  
 12 m band (No. 8): 24.89 ... 24.99 MHz  
 10 m band (No. 9): 28.0 ... 29.7 MHz  
 6 m band (No. 11): 50.0 ... 52.0 MHz

Output power (into 50 ohms, PEP at 13.8 V DC):	30 ... 37 dBm +1 -2 dB (6 m: -4 dB)
Efficiency:	> 0.75
VSWR (at 50 ohm real):	<= 2
Upper / secondary wave attenuation to 50 MHz:	>= 45 dB
Upper / secondary wave attenuation from 50 MHz:	>= 60 dB
Intermodulation third and higher order: (fmod 1.0 kHz + 1.5 kHz, @ 7.1 MHz @ 4 W PEP)	>= 35 dB (PEP)
Modulation types:	AM, DSB, SSB, CW, FM-N
Modulation bandwidth:	1.8 ... 9.6 kHz depending on the operating mode
Rise / fall time of RF signal (CW / FM):	0.1 ... 9.9 ms selectable
Switch-on delay PTT / button → HF Out:	2 ... 255 ms selectable
Switch-off delay PTT / button → HF Out:	< 2 ms + release time
Muting delay PTT / button off → RX:	0 ... 630 ms selectable
Shift TX / RX frequency:	0 ... ± 19,999,999 Hz adjustable (1 Hz)
VOX holding time:	OFF, 10 ms, 250 ms, 500 ms ... 2500 ms selectable
Squelch / Anti-VOX:	From -82, ... -34 dB adjustable
ALC:	0 (off) ... 100% action set

## Special features:

- Adjustment option for maximum SFDR (Spurious Free Dynamic Range)
- Adjustment option for minimal IM
- CW keying possible with VOX (setting 10 ms)
- Combined SSB / CW (SBCW) with the possibility of sending CW in SSB sideband
- Adjustable FM deviation
- Two-tone test generator with adjustable frequency and level
- Modulation / power and temperature measurement
- Internal transmit / receive switch
- Protection circuits for overcurrent, overvoltage, overtemperature (> 55 °C)
- Switching output "Open collector" for PTT, RS-232 signal (TTL) for band
- Equalizer and adjustable sidetone for microphone channel
- Automatic adaptation to impedance of the antenna

## 10.3 Operation

Transmission mode is only available with user interface version 300 or higher. The bar graphs in the upper panel show some parameters for the transmitter:

- "Mod.": Modulation degree in %. This display shows the instantaneous modulation voltage from the microphone input. It is always active, regardless of whether the transmitter is working or not. Thus a permanent control of the microphone setting and its operation is possible. The bar turns from green to red when the modulation level reaches 100% (limit of the signal).
- "PWR": Output power in watt. Average power consumption of the RDR52 over a period of 0.8 s including effective output power and power dissipation. The bar graph turns yellow when the transmitter starts to emit power.
- "T": Temperature of the transmitter board or motherboard (whichever is higher). When reaching 55 °C the transmitter is switched off.

*Note:* The labeling of the bar graphs may vary depending on the software version.

The transmitter can be switched on only by PTT, key, VOX or TUNE, in case its frequency lies within the specified frequency bands. The PTT, key and VOX signals are generated via connected switches or the VOX function. The signal Tune can be generated via the virtual key of the same name if the active setting function of the user interface is the frequency.

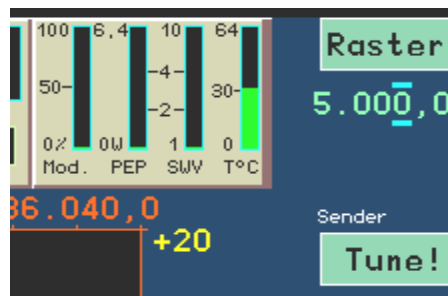

With active frequency setting = function "Tune!".

Tapping the button will trigger the tuning function. The transmitter will be switched on with 0% modulation and minimum power. It generates a CW carrier at the set frequency.

**Caution!** If the test generator is activated, a carrier with 25% of the transmitter set power will be created in the AM mode immediately. In modes without generating a carrier, a signal will be created with the test frequencies as modulating frequencies.

The active function changes from the frequency to the bar graph of the modulation (inversion of the colors). This indicator is now used to adjust the transmit power or modulation level when the test generator is active. The transmit power can be varied; the modulation display shows the set value from 0% (minimum possible power) to 100% (according to power setting in the Transmitter dialog). As long as the tuning function is active, no other setting can be selected. Only the Transmitter dialog can be opened. Tapping the tune button again (now labeled "Off!") will cancel the tuning function and return to normal operation.

**Caution! Never switch on the transmitter without a connected and at least reasonably tuned antenna or 50 ohm terminating resistor ("dummy load")!**

**Operation of the transmitter on currents with very bad SWV (open circuit or short circuit) will cause the transmitter to switch off immediately if the power set is high enough. When the transmitter is set to full power (+37 dBm, CW, FM or Tune at 100%), operation at idle or a short can cause damage to the transmitter!**

The transmitter of the RDR52 does not have an internal antenna tuner. An antenna with a correspondingly low SWV must thus be connected to get a good RF yield (radiation). However, the transmitter is tolerant of poor antenna adjustment. In addition, it has an internal resistance that is variable within limits. This flexibility results from the transmitter's fundamentally different operating principle to linear (analog) power amplifiers. In a range of SWV from 1 (ideal match) to about 2.5, the transmitter changes its output impedance so that much of the power goes to the antenna.

However, this automatic impedance matching is very frequency (band) dependent and is also affected by the reactances of a non-ideal (to real 50 ohm) configured antenna. In general, however, it usually does not require the use of an external antenna tuner. Especially not when highly effective and well tuned antennas are used, which should always be the case with such low power.

Impedance readjustment operates closely in conjunction with the internal protection circuits. As long as the permissible values for output voltage (approx. 18 Vrms) and internal transmitter current (1.5 A) are not exceeded, almost any antenna can be connected.

In case of very bad SWV, the power in the Transmitter dialog may not be adjusted beyond 30 dBm. At this value, the transmitter hardly switches off even at no-load or short circuit (but avoid these extremes!). This allows e.g. even an RF emission only with a telescopic antenna, a short wire or a passive loop without adaptation. However, due to the low efficiency of such designs, only little RF power is actually radiated. Nevertheless, this can be sufficient for short-distance communication.

Via the callable dialogues (see section 6. "Dialogs") the configuration of the transmitter and the microphone input are possible within wide limits. Both dialogs are integrated with the spectrum display and the transmitter display panel, making precise control of settings possible.

The transmitter has control outputs for controlling an external PA. These signals can be output via the configurable connections of the microphone and Morse key sockets (see Transmitter dialog).

- CAT Out: TTL / 2.5 / 3.3 V CMOS signal with RS-232 protocol 8N1 (variable baud rate). Each band switch outputs a byte with the band number (see technical data). If tuning outside of a band, "0" is output.
- PTT Out: TTL- / 2.5 / 3.3 V CMOS signal to switch on a PA (**high-active, no open collector!**).

# 11. Exciter

The RDR52 can be equipped with a broadband modulated signal generator ("Exciter"). It is located on module C4 of the second RDR52 slot.

## 11.1 Overview

The Exciter consists of a digital sine generator according to the DDS (Direct Digital Synthesis) principle, a quadrature modulator and a DAC for converting the digital values into an analogue output voltage. It can generate all modulations (except DAB) that can be received by the RDR52 in broadband and high quality. The modulation can occur by an internal test generator or by the microphone signal. Sampling with the manual button is also possible (CW operation). In conjunction with an external power amplifier, the exciter can be used as a transmitter.

## 11.2 Specifications

Frequency range	100 kHz – 156 MHz
Power output (into 50 ohm, PEP):	0 ... +10 dBm, +1 ... -2 dB
VSWR (at 50 ohm real):	<= 1.5
Upper / secondary wave attenuation to 50 MHz:	>= 50 dB
Upper / secondary wave attenuation from 50 MHz:	>= 60 dB
Intermodulation third and higher order: (fmod 1.0 kHz + 1.5 kHz, @ 7.1 MHz @ 10 mW PEP)	>= 60 dB (PEP)
Modulation types	AM, DSB, SSB, CW, FM-N, FM-W
Modulation bandwidth:	1.8 ... 9.6 kHz depending on the operating mode
Rise / fall time of RF signal (CW / FM):	0.1 ... 9.9 ms selectable
Switch-on delay PTT / button → HF Out:	2 ... 255 ms selectable
Switch-off delay PTT / button → HF Out:	< 1 ms + release time
Muting delay PTT / button off → RX:	0 ... 630 ms selectable
Shift TX / RX frequency:	0 ... ± 19,999,999 Hz adjustable (1 Hz)
VOX holding time:	OFF, 10 ms, 250 ms, 500 ms ... 2500 ms selectable
Squelch / Anti-VOX:	From -82, ... -34 dB adjustable
ALC:	0 (off) ... 100% action set
Limiter / compressor:	100% (off), 50%, 25% modulation

### Special features:

- CW keying possible with VOX (setting 10 ms)
- Combined SSB / CW (SBCW) with the possibility of sending CW in SSB sideband
- Adjustable FM deviation
- Two-tone test generator with adjustable frequency and level
- Equalizer and adjustable sidetone for microphone channel
- Dynamic compressor / distortion-free limiter

## 11.3 Operation

Transmission mode is only available with user interface version 400 or higher.

The operation of the Exciter is analogous to that of the transmitter (see section 10 "Transmitter"). The setting options for optimizing the polar transmitter are not available in the Transmitter dialog. However, the exciter has a set value for a very efficient limiter / dynamic compressor.

## - "Limiter Mod. %"

This set value can be changed in steps of 25%, 50% and 100%. The value indicates at which level of the modulation (left bar in the upper panel) the modulation is limited. At the same time, the full output power is generated from the beginning of the limitation. Effectively, at 25% this means an additional amplification of the modulation voltage by a factor of 4 (12 dB), at 50% by a factor of 2 (6 dB). These are the values by which the dynamic range of the modulation is compressed.

The limiter threshold and thus the full modulation is displayed in yellow in the modulation bar.

The use of the limiter / dynamic compressor allows a higher modulation of the modulator and thus a higher average output power in SSB operation. At the same time, distortions and overmodulations ("splatter") are effectively avoided. The limiter operates distortion-free between limiter threshold (yellow modulation bar) and overmodulation of the microphone input (red bar). In conjunction with the ALC of the microphone amplifier in low levels (only to prevent overmodulation) an optimal modulation can thus be achieved.

## 12. HiFi DAC

The RDR52 can be equipped with an additional HiFi Audio Stereo DAC (Digital-to-Analog Converter). It is located on module C5 for the second RDR52 slot.

The DAC has a line-out output (see picture on page 12) for controlling external devices (recording devices, stereo amplifiers, PC sound card, etc.). It outputs the same audio signal that can be heard with headphones and speakers. However, the volume can be set separately via parameter "AF Level %" in the System dialog.

*Note:* If the RDR52's internal speakers are turned off (Setup dialog), the associated volume control will affect this parameter.

### 12.1 Specifications

Resolution:	2 channels 24 bit
Frequency range:	16 Hz – 20 kHz
Output voltage (unloaded):	1.3 V <sub>eff</sub>
Output resistance:	1 kOhm
Minimum load resistance:	5 kOhm
Distortion factor (@1 kHz, -3 dB full scale):	<= 0.003 %
SNR (A-weighted):	>= 104 dB
Connectors:	Jack socket 3.5 mm

## 13. Tips and tricks

Below are some hints and more in-depth descriptions for using the RDR52.

### 13.1 CW and Digimode reception and operation of the transmitter

In CW operation, the RDR52 offers a number of setting options. The different variants and associated functions of the RDR52 will be explained in more detail below.

#### Basic information

For receiving (and for devices with transmitter or exciter also transmitting) Morse code, hereafter simply called "CW operation", the RDR52 offers three independent demodulators:

- "CW": Spectrum-based directly at the set frequency with adjustable pitch (CW shift).
- "SBCW": Spectrum-based as adjustable tone in the sideband (LSB below 10 MHz, USB from 10 MHz).
- "DIGI": Time-based with adjustable storage at the set frequency.

Each of the demodulators has its own characteristics. They will be explained in more detail below. Fundamentally, the properties of the respective signal processing also apply:

- Spectrum-based: Fine tuning of bandwidth and its shift, extremely high selectivity, auxiliary tools such as notch filters, noise reduction, noise blanker and mute / squelch available, higher signal throughput time, low signal distortion possible.
- Time-based: Few levels for bandwidth available, moderate selectivity, sometimes coarser frequency settings, no helper tools, low signal turnaround time, very low signal distortion.

Just these properties can decide the choice of demodulator, for example, if a very low signal propagation time is required (DIGI) or an extreme selection against adjacent channel interference (CW / SBCW).

CW operation at the RDR52 is always carried out with a single-pole morse key. It must be connected to a freely configurable connector of one of the sockets KEY or MIKE to ground of the socket. See also Transmitter dialog An internal keyer does not exist. The selected connector must be assigned the signal "KEY In" in the TX dialog. If an external PA is connected, a connector should also be assigned the signal "PTT Out" and connected to the PTT input of the PA (**Attention!** A level converter is usually necessary!). Thus, the internal timing can be used as described below.

#### Time behaviour of the signal generation

The generation of clean signals with well defined and not (noticeably) fluctuating delay times is essential for efficient CW operation. The picture below shows the basic procedure when generating a single CW pulse. The assignment of the signals to the oscillograms applies from top to bottom as follows:

- PTT In (yellow): The signal at the input, generated by the contact of the morse key (l-active).
- PTT Out (red): The PTT output signal for controlling the PA (h-active).
- RF Out (green): The high frequency signal generated at the antenna output.
- Audio Out (blue): The audio output to headphones and speakers.

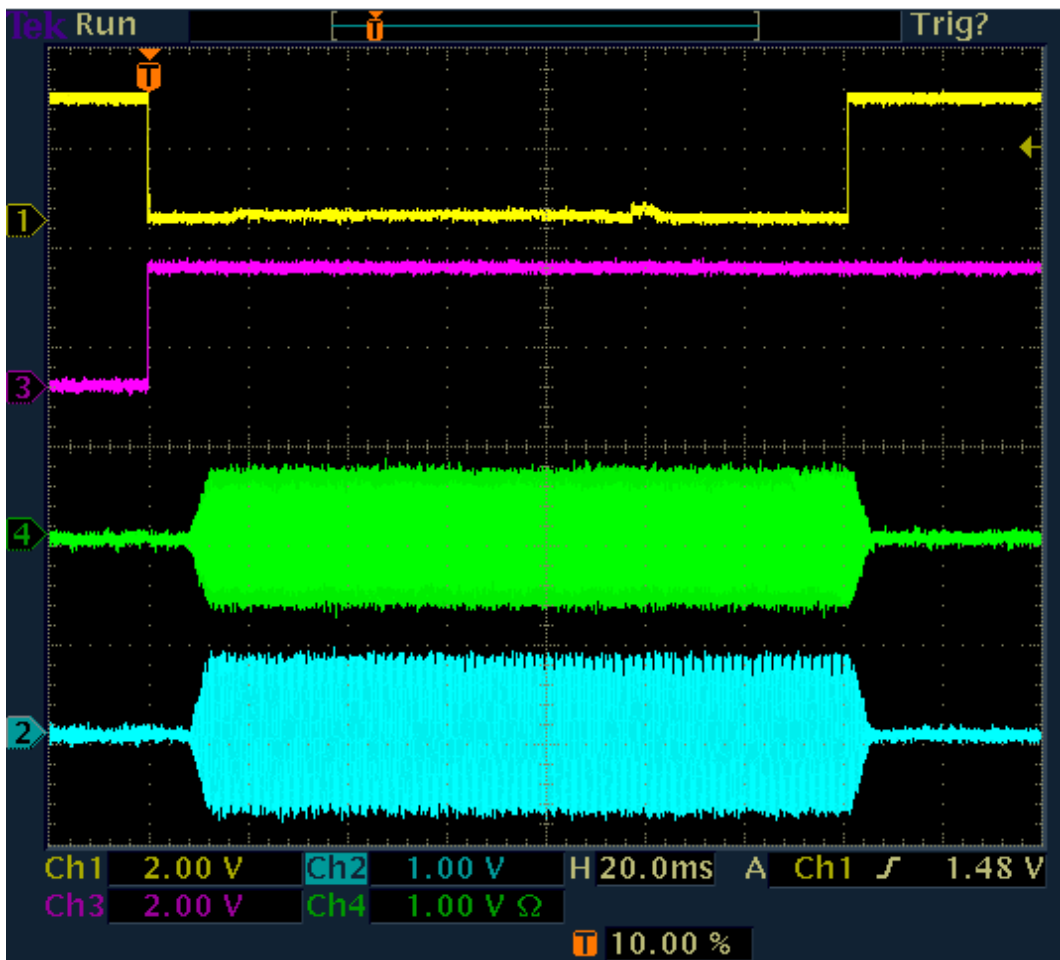

**A CW pulse**

The generation of a CW pulse (dot or dash) starts when the key is pressed (yellow line goes from high to low). At the same time, the PTT signal is activated for an external PA (red line from l to h). At the same time, the receiver (RX) of the RDR52 will also be muted.

The generation of the RF pulse (green) starts after the time "Delay RF ms" has elapsed (TX dialog, set to 10 ms in the picture). At the same time, an audio signal is generated (sidetone, blue) if the sidetone is activated in the Microphone dialog. Both signals are increased from 0 to the defined levels in a linear "ramp" (rising edge) (setting in TX dialog, value "Risetime RF ms", here set to 4 ms). The signals are generated as long as the key is pressed.

After releasing the key and a short debouncing time (about 0.5 ms), the signal generation ends. The levels are again reduced to 0 in a linear ramp.

The PTT Out signal remains active for a while, at least until the end of the signal edge (key on h + debouncing time + signal edge duration).

It is still active in the example (end not visible). The additional time corresponds to the setting "RX Delay ms" in the TX dialog. For this time span, the receiver is also kept muted. The meaning behind this is the suppression of audible remnants of the own transmission signal due to the signal propagation times and the transient effects of spectrum and control.

When PTT Out goes low again (inactive), the PA is turned off and the RX is re-engaged. If the RX Delay time is set long enough, the RX will not receive any signal and the control will return to the level at the time of muting (or possibly higher, if higher reception levels occurred in the meantime). This means that the RX has full sensitivity immediately after switching off the PA (or switching the antenna relay).

#### CW character sequence with RX Delay ("semi-BK")

Usually, not just a single dot or dash is sent, but a more or less continuous sequence (complete letters and words).



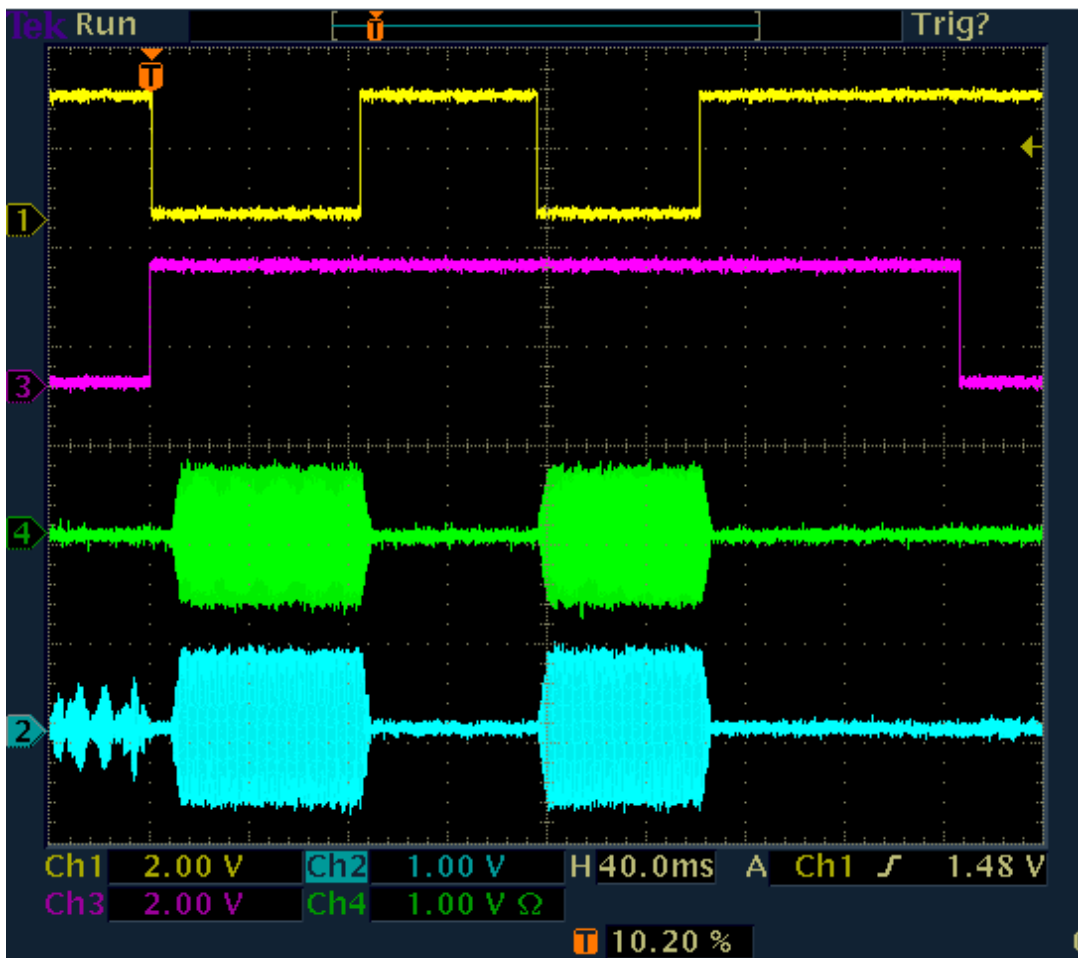

Sequence of CW pulses without "intermittent listening" (RX Delay > character pitch)

Whereas: As long as PTT Out is active, the signal is generated immediately with KEY In. There is no time lag "Delay RF" between key and signal generation. Thus, the RF pulses (and the sidetone when active) follow exactly the keystrokes.

Only when PTT Out has dropped and then / again a keystroke occurs, the RF delay is again "integrated". It follows: **Compared to the keystroke, the first impulse is always shortened by the time "Delay RF"!** **All the following impulses are exactly correct.** If the first impulse is also to be largely accurate, the Delay RF must be set very small (at least 0.1 ms are possible).

**Caution!** The delay time "Delay RF" between PTT Out and the onset of high frequency generation protects the PA (transfer relay). It must not be too short (please note the PA's specifications)!

During the complete character sequence, the PA stays switched on and the RX mutes as long as no pause is greater than the "RX Delay" time.

If the RX Delay time is set very low, the PA shuts off between the characters and the RX is engaged. Depending on the other settings, a more or less long reception of your own transmission takes place. The onset of reception and the duration of self-reception are mainly dependent on the cycle time of the selected demodulator including the filter.

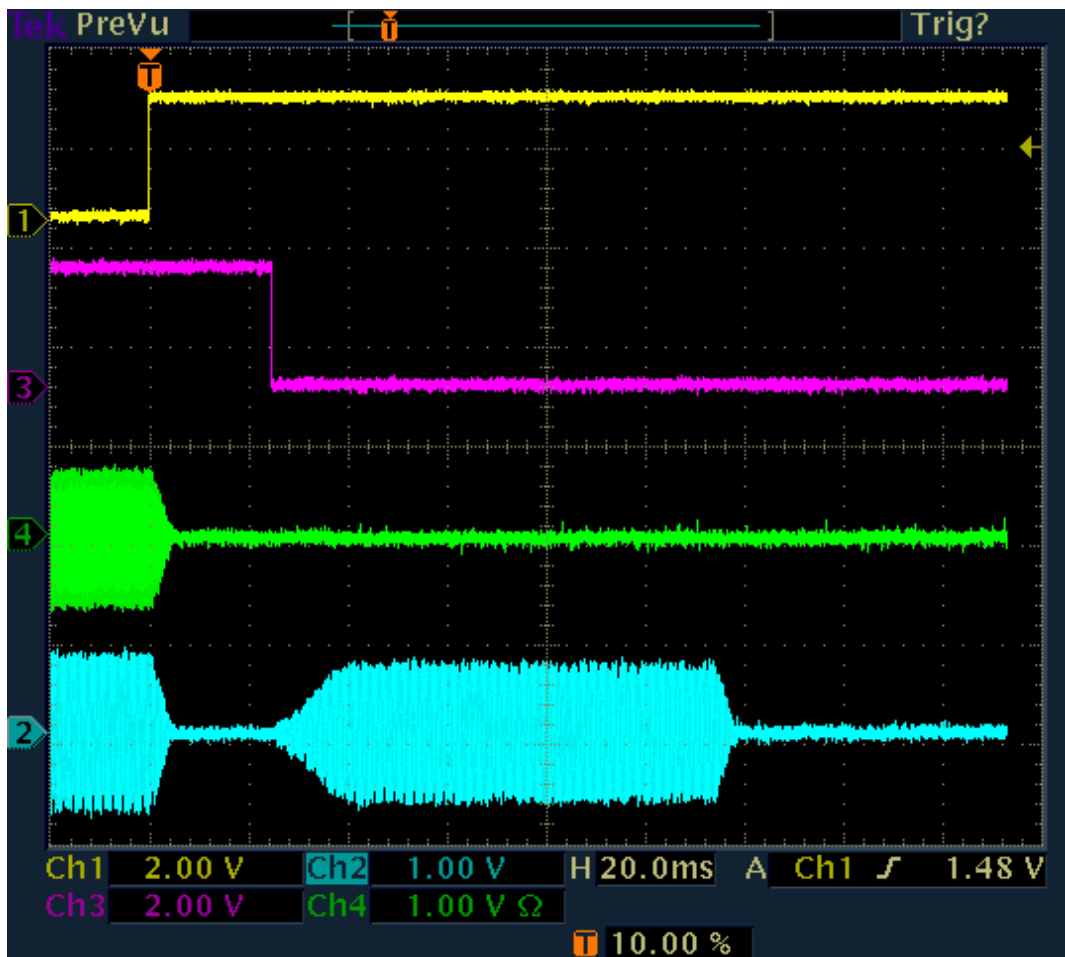

### Self reception of the broadcast with a short RX Delay

In the example, RX Delay is set to 20 ms. 20 ms after the end of the pulse edge PTT Out drops and the RX becomes active again. It reproduces the self-received transmission signal stored in the signal path. Playback ends after the signal propagation time of self-receipt through the entire receiver block.

In the example, the propagation time is about 115 ms (end of RF transmission until the end of playback of the RX). This is a typical value for the spectrum-based demodulators when setting the audio resolution (Setup dialog) to 20 Hz. At 40 Hz, the time is reduced, at 10 Hz it is longer.

The self reception possibly conceals received signals. Particularly disturbing is that it also sets the control on the value of the self-reception level. This is usually higher (corresponding to the blocking attenuation of the TX / RX switching) than weak received signals. Depending on the control setting (speed), the receiver therefore takes a while to again possess full sensitivity for weak received signals.

You should always set the RX Delay to at least as long as the self reception passes through the RX block, so in the case shown to 120 ms. Then no own signal (disturbing) is audible or drives the RX to low sensitivity by modulation of the control.

### CW character sequence without RX Delay ("full-BK")

In the extreme case RX Delay = 0, the RDR52 never mutes the receiver. It remains active during the entire duration of the transmission (PTT Out to high level). Thus, a self reception of the transmission is always present. It also does not start until after the end of the broadcast. Instead, the RX always returns a complete picture of what happened at the antenna connector (own signal attenuated). The signal propagation time within the RX is of course retained and thus determines the meaningfulness of this operating state.

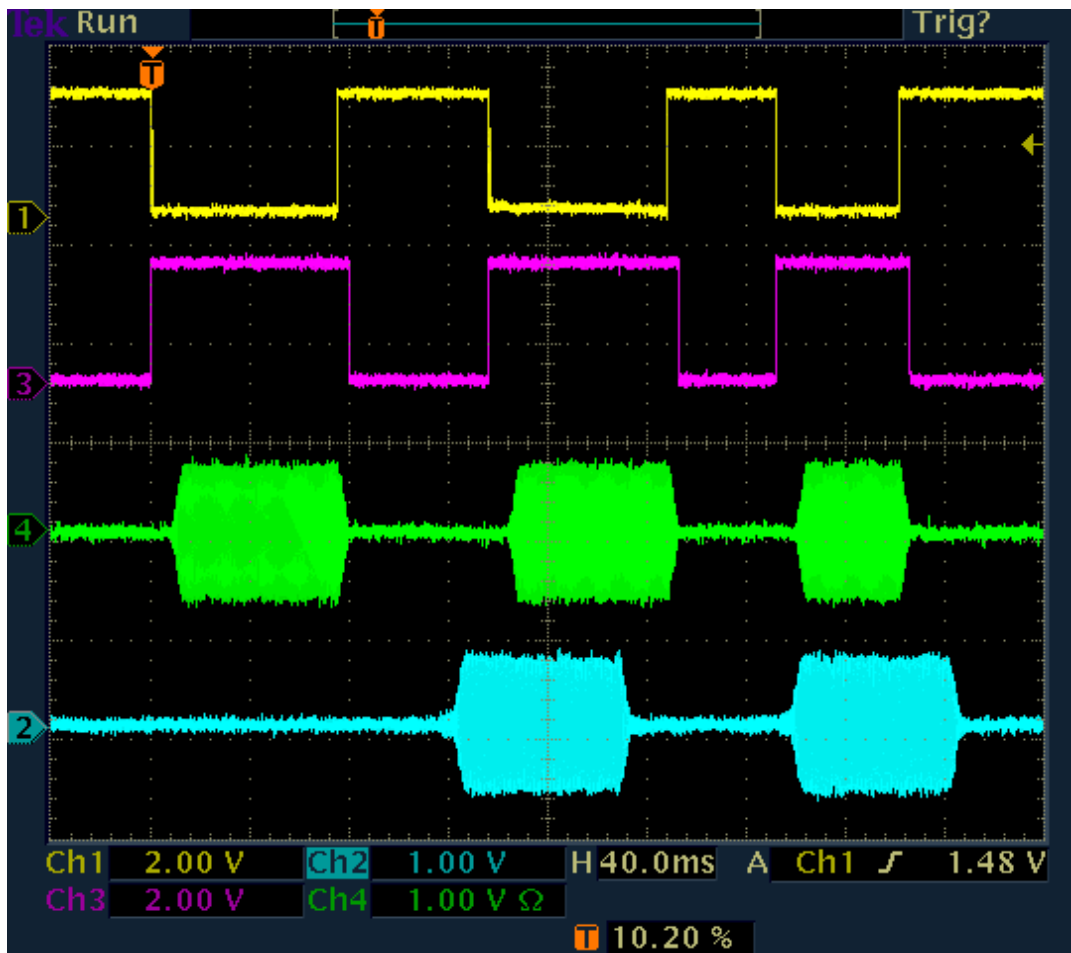

### Full-BK for spectrum-based demodulators

Because the RX is always active, no sidetone (if set) is generated. So you only hear the (delayed) own transmission and the received signals, if strong enough (control always adjusts to the level of self reception). In the picture above, the RX cycle time is in turn approx. 115 ms.

**Caution!** At full-BK, all characters are always shortened by the time "Delay RF".

The picture below shows the full-BK operation with time-based demodulator (DIGI). Here the signal propagation times are much shorter. They depend on the filter bandwidth. It is 500 Hz in the example, resulting in a propagation time of approx. 7.5 ms. When increasing or decreasing the bandwidth, it decreases or increases approximately reciprocally (at 250 Hz for about 15 ms, etc.).

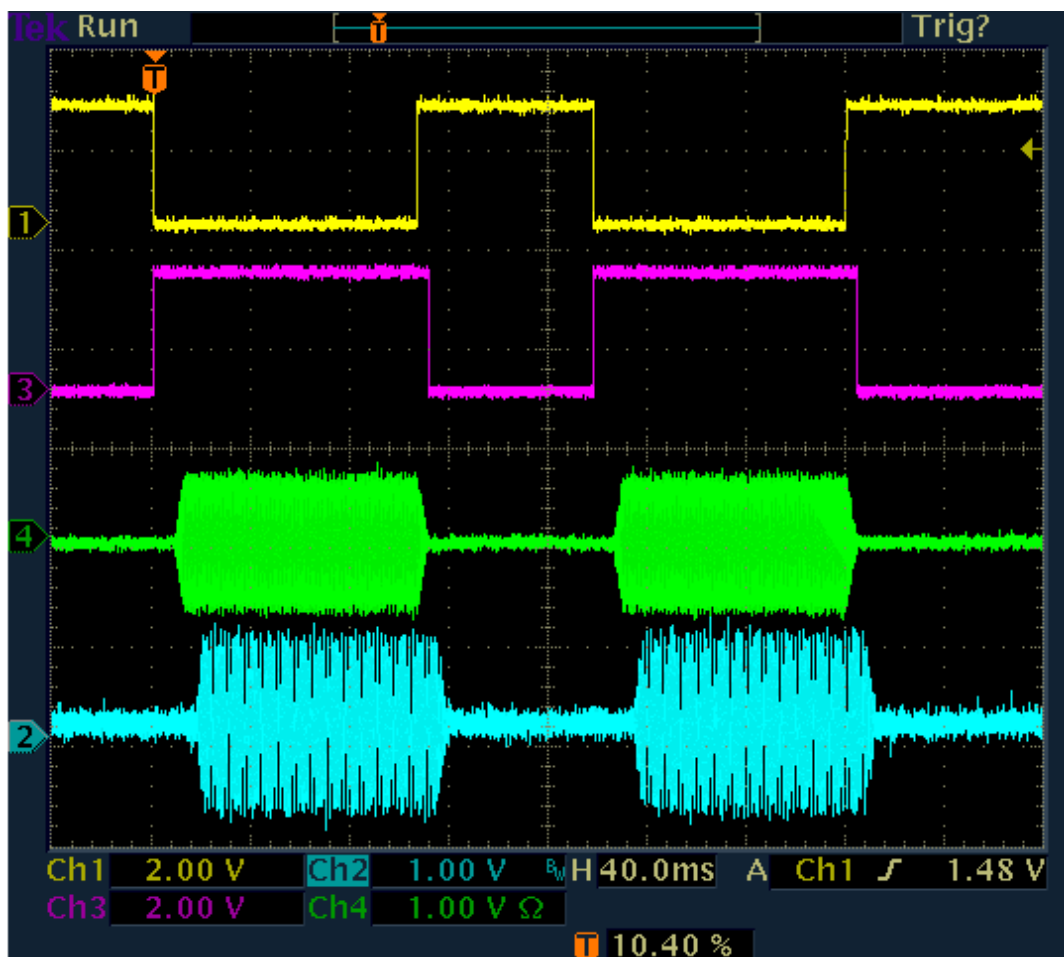

### Full-BK for time-based demodulators

In the case of full-BK with DIGI, setting the control to the self reception level may be annoying. If the other received signals are much weaker, they are barely audible. You should choose semi-BK with very low RX Delay (and sidetone) in this case. The RX is then indeed disabled during the transmission and shortly thereafter, but immediately after a (very short) RX Delay fully sensitive again.

### Comparison of the demodulators

CW:

- Functionality according to the pictures for operation with spectrum-based demodulator.
- Pitch on reception and sidetone on transmission directly result from the set value "CW Pitch".
- Transmission frequency is always the reception frequency (usually in the center of the display)  $\pm$  TX Shift (TX dialog).
- Throughput time is longer, depends on audio resolution (Setup dialog).
- Extremely narrow and steep-edged bandwidths down to 10 Hz can be realized.
- DNR, NB and notch filter available.
- "Absolutely noise-free" reception possible by setting the demodulator threshold between noise and received signal.
- Temporary (as long as settings are not changed) sidetone independent of CW-Shift is possible if the input "PTT-In" is utilized instead of "KEY-In" and the desired tone is set for "Freq L" in the Setup dialog.

SBCW:

- Functionality according to the pictures for operation with spectrum-based demodulator.
- Pitch on reception results from storing the received signal towards the center of the display ("SSB mode").
- Sidetone during transmission results from the "Freq L" setting in the System dialog.
- Transmission frequency is always the reception frequency (usually in the center of the display)  $\pm$  Freq L (thus in the SSB-sideband)  $\pm$ TX Shift.
- A two-tone signal can be sent (Freq L and Freq R > 0).
- Throughput time is longer and depends on audio resolution (Setup dialog).
- Bandwidths according to the set SSB bandwidth.

- DNR, NB and notch filter available.
- "Absolutely noise-free" reception possible by setting the demodulator threshold between noise and signal (if no SSB signal is present).

#### DIGI:

- Functionality according to the pictures for operation with time-based demodulator.
- Pitch on reception directly results from the set value "CW Pitch".
- Sidetone during transmission results from the "Freq L" setting in the System dialog.
- Transmission frequency is the reception frequency (usually in the center of the display)  $\pm$ Freq L  $\pm$ CW Pitch  $\pm$ TX Shift.
- A two-tone signal can be sent (Freq L **and** Freq R > 0).
- Pass-through time is short and depends on bandwidth.

The frequency of the transmitted signal with DIGI depends, among other things, on both the CW Pitch and the selected audio test frequency (similar to SBCW). To transmit exactly at the reception frequency, CW Pitch and Freq L must be exactly the same. CW Pitch (change of the receive pitch) or Freq L (change of the sidetone pitch) can be used as "XIT" for exact pitch tuning to the frequency of the QSO partner.

#### Sidetone

While transmitting, the RDR52 allows the playback of a sidetone through the audio outputs next to operating the RX (full-BK only with RX Delay = 0). The sidetone is set in the Microphone dialog (value "Monitoring" = volume of the sidetone in %). When the dialog is opened and when transmitting in a mode other than CW (or SBCW or DIGI with activation of the "KEY In" input), the microphone signal is always audible.

The CW sidetone is heard only when the morse key is pressed (regardless of the status of the transmitter). To do this, the value "Monitoring" in the Microphone dialog must not be set to 0 **and** the RX Delay in the TX dialog must be greater than 0 (otherwise RX is always received during transmission).

The sidetone is generated in the RDR52 by bypassing (almost) all signal processing units. It has no noticeable delay to the direct transmission signal. But it also suffers the shortening of the first CW pulse by the RF Delay when switching on the transmitter. The edge shaping corresponds to that of the RF transmission signal. In doing so, it produces an exact (temporal) replica of what the receiver of his own broadcast hears.

The frequency of the sidetone depends on different settings. It largely corresponds to the frequency that a receiver of the program hears with the same setting of the RX (i.e. exactly the same frequency setting / CW Pitch, etc.) or the frequency that is heard even during reception. The setting can also be adapted to your own habits or frequency inaccuracies (use of the test signal "Freq L" in the System dialog as a correction value).

## 14. Enhancements and Software Updates

The hardware and software of the RDR52 are constantly being further developed. The following chapters explain the changes and new functions.

### 14.1 Vx13

The firmware version RDR52AV213 (devices without transmitter / exciter) and RDR52AV413 (devices with exciter module C4) contains minor error corrections (occasionally wrong characters or graphic symbols not drawn correctly) and functional extensions. This includes the new WiFi driver RDR52WLANV60.

Caution! The RDR52 firmware from version Vx13 can only run in combination with a WiFi driver from version V60! The WiFi driver must be loaded before updating the firmware (see section 7.3 "Software Upload")!

New functions:

- Automatic connection to Bluetooth devices.

The RDR52 can connect to Bluetooth devices that can output audio (headphones and speakers) via the built-in network controller. When switching on the RDR52, this controller is normally switched off and must first be activated by calling up the WiFi dialog. From software Vx13 (firmware RDR52AV213/413 plus RDR52WLANV60) an automatic activation of the controller can be switched on in the Setup dialog.

RF Gain Control:	Auto
FM-W Deemphasis (s):	Off
Audio Lowpass (kHz):	15
Audio Highpass (Hz):	20
Bluetooth active at start:	On
Resolution Audio (Hz/Bin):	20

When set to On, each time the RDR52 is powered on, the network controller will also be powered on. It then automatically searches for available Bluetooth devices. If it finds the device **that was last connected**, it reconnects and sends the audio signal to that device. The process corresponds to the manual connection setup as via the WiFi dialog and also takes a similar amount of time (approx. 12 - 15 s).

If you want to use the Bluetooth audio output (with or without automatic connection), please also note the following general information:

- The network controller requires additional power and generates low self-reception interference in the frequency range around 15.5 MHz.
- Audio transmission over BT is always compressed and may degrade audio quality (not recommended with high quality FM stereo reception).
- Bluetooth is a complex network structure with many variants and versions, which was primarily designed for use in devices with powerful processors, lots of memory and extensive operating systems (PC, notebook, tablet, smartphone, ...). All this is not available in the RDR52. Therefore the RDR52 can only offer limited BT functionality (A2DP audio output on simple devices). In particular, "smart" devices with additional functions such as source switching, volume / tone control, data transmission, etc. are often not connectable.
- Test the device that you may want to connect to the RDR52 automatically when you turn it on, before doing so thoroughly manually (WiFi dialog, connect several times, disconnect, search again, etc.).
- Use auto-connect only with devices that can reliably connect to the RDR52.
- Deactivate the automatic function if the device itself is not switched on or is not within range when it is switched on.
- The RDR52 checks a maximum of 10 s after switching on whether the last connected device can be found again. If it is not found or does not connect to the RDR52, the network controller remains active (unnecessarily) but does not regularly search for the device again. Turn off BT in the WiFi dialog or try a new connection manually in the dialog.
- The failure to establish a connection (regardless of whether it is manual or automatic) can have many causes (in addition to a possibly incompatible device ↔ RDR52). Here is a small selection of the most common causes:
  - Other BT devices in range are active and trying to connect to the RDR52.
  - The 2.4 GHz band is heavily disturbed (WiFi connections, BT devices, wireless mice / keyboards, etc., microwave ovens, poorly suppressed televisions, computers and monitors,

- especially their cable connections, etc.).
- The antennas on the RDR52 and possibly on the BT device are not attached or emit very poorly (align them differently, remove nearby metal objects).
- The battery in the BT device is low.

## 14.2 Vx14

The firmware versions RDR52AV214 (devices without transmitter / exciter) and RDR52AV414 (devices with exciter module C4) contain some functional enhancements as well as changes in the graphical user interface. This includes the new WLAN driver RDR52WLANV80.

Caution! The RDR52 firmware from version Vx14 can only run in combination with a WiFi driver from version V80! The WiFi driver must be loaded before updating the firmware (see section 7.3 "Software Upload")!

New functions:

- **Automatic activation of the WiFi access point when switching the device on.**

The set value "Bluetooth active at start" in the Setup (see above at Vx13) has been renamed to "LAN active at start". The set value can now be switched between "Off", "BT" (as above for Vx13) and "AP". Setting "AP" activates the access point when the RDR52 is switched on.

- **Remote control of a preselector RAP1.**

The RAP1 preselector can be remotely controlled by the RDR52 in two different ways:

- ➔ Via the RF cable at the antenna connector. For this purpose, the "Antenna Control" setting in the Setup must be switched to the value "RAP". The RDR52 then outputs control signals as when controlling an antenna RLA4 or RFA1. A connected RAP1 (between antenna and RDR52) receives these signals and adjusts its filter frequency to match the reception frequency of the RDR52. It can also pass the signals for directional control of an RLA4 from the RDR52 to the antenna. In the user interface of the RDR52 the set value for direction control appears in the upper right corner, just like when "RLA" is switched on in the Setup.
- ➔ Via WiFi connection between RDR52 and RAP1. This variant corresponds to the remote control of an RSW3 or 4 control unit (see page 34). Accordingly, "RSW" and the serial number of the RAP1 must be set in the Setup.

Remote control of a RAP1 allows it to be used as a accompanying preselector. Each time the frequency on the RDR52 is adjusted (by wheel, calling up slots, etc.), the RAP1 is automatically retuned. If the frequency is adjusted manually at the RAP1, there is no feedback, the frequency of the RDR52 is never adjusted. This allows the RAP to be set as desired at any time without affecting the Pocket.

The direction of any RLA4 antenna connected to the RAP (only RAP1 version B and D) can be remote controlled. In this case, there is a feedback from the RAP to the RDR52 (only with WiFi!), the set value in the user interface is adjusted concurrently with the adjustments on the RAP. For further notes see description of preselector RAP1. The following special features exist with remote control by the RDR52:

- ➔ Bypass circuit of the RAP1: By tapping on the label "RAP" of the RLA4 set value (in case of WiFi connection, the antenna current is displayed instead of "RAP"), the RAP can be switched to bypass the filters (display "0-30MHz" in the RAP). This state is indicated by a red-framed set value.



**Caution!** Manual adjustments at the RAP do not reset the display in the RDR52! To reset (white frame again) and to enable the possible filter control by frequency adjustment again, the "RAP" (or current) display must be tapped again.

- ➔ Dual connection via WiFi and RF cable: If a WiFi connection is active and the Setup switches from "RSW" to "RAP" to RF control, undefined states may occur. Before changing the connection type,

the currently existing connection must first be safely disconnected (Setup to "Off", access point switched off). Select the desired connection type in the Setup afterwards (RAP or RSW). Activate the access point only afterwards if required ("RSW").

- **Deletion of unneeded bar graph displays in the upper control panel.**



There is only one bar display left. It either shows the microphone level (transmitter level for RDR52C3/4) or the audio level of the received signal. Switching is done by tapping on the bar. The display is linear (%) not logarithmic (dB). Therefore, the display range is limited. However, levels close to the limit (clipping, 100%) are clearly visible.

*Note:* If the constant "fidgiting" of the bar display is disturbing, you can switch to "Mike" and set the microphone volume to 0 in the Microphone dialog.

- **Preparation for the installation of decoders for digital modulation.**

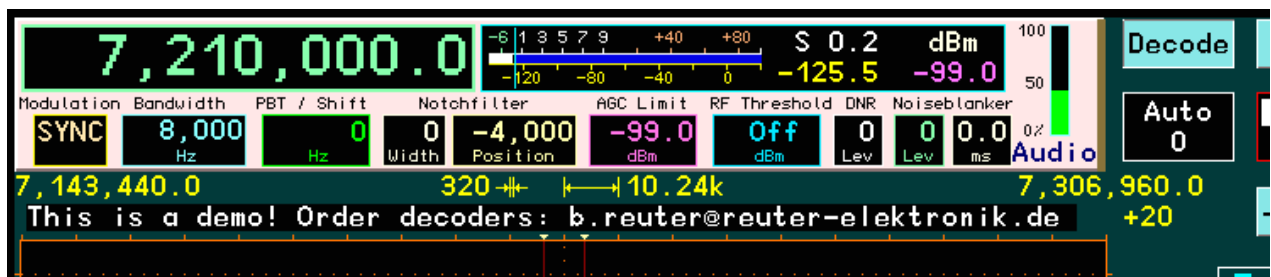

The hardware and software of the RDR52 has been prepared for the possibility of demodulating / decoding "digital" modes. For this purpose, the necessary signals are generated in the FPGA and routed to the microcontroller of the operator control. Decoding and display can take place here. Due to the limited capabilities of the RDR52 (memory capacity, free processing power of the controller, no text processing in the operating system, space on the user interface, etc.), the following limitations exist:

- ➔ Display in a single line of 62 characters as text running to the left. Newly received characters are inserted on the right, the characters disappearing on the left are irretrievably lost.
- ➔ To display the text line, the spectrum diagram is reduced in height by one subunit. Accordingly, less space is available for the vertical height of the spectrum / waterfall.

The operating mode to be decoded is selected by tapping the set value under the button "Decode". When "Auto" is selected, the RDR52 will attempt to determine which mode contains a signal that is within the audible range of the spectrum. The success is strongly dependent on the reception settings such as existing decoders, bandwidth, audio resolution, reception level and much more. (Further notes in the description of the individual decoders). You can manually select the decoders that are installed and activated in the software.

The numeric display below the mode selection shows the measured value of the transmissionspeed (baud), or can be set to preset a specific speed (depending on the decoder).

Tapping the "Decode" button will start the selected decoder. To do this, the height of the spectrum is decreased and the scrolling text line is displayed. Depending on the decoding success, the received characters appear in the line. To switch off, the button must be tapped again, the text line disappears and the spectrum reappears in full height.

*Note:* The available decoders depend on the respective software version of the RDR52 (in Vx14 initially all without function with display of the demo text line). Activation of a functionally available decoder is done by entering an activation code, just as when activating other additional options (see page 48).



- Different color table for waterfall

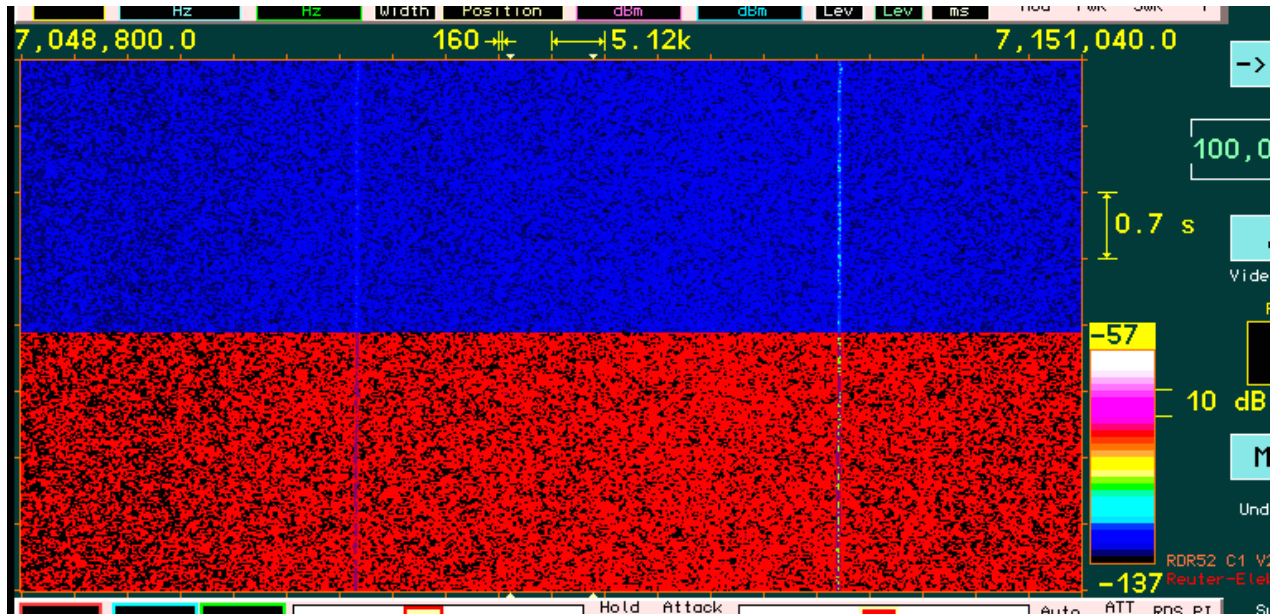

The color gradation of the levels in the waterfall (given by the color table next to the diagram) can now be switched between two variants. The effect on the representation is exemplarily shown in the image (weak signal approx. 3/4 to the right).

Old representation: The previous color gradation was chosen in such a way that small level differences produce the largest possible color differences in the image. As a result, even small level changes result in a large contrast (bottom half of image, signal yellow against red background).

New representation: Common on high resolution screens (PC) is a color gradation similar to the rainbow colors. This looks "more pleasing to the eye", but results in reduced contrast for small level changes. This is usually the case only within one color, e.g. from dark blue to medium blue. In the image above, the level position was chosen to produce the highest possible contrast with this color choice (medium blue to cyan), aided by the RDR52 display's low color depth (256 colors vs. 16 million or more for the PC).

Switching the color table is done by tapping on the table.

## 14.3 Vx15

The firmware version RDR52AV215 (devices without transmitter / exciter) and RDR52AV415 (devices with exciter module C4) contains functional enhancements as well as minor bug fixes. This includes the new RDR52WLANV90 WLAN driver.

New features:

### Abort DAB start when switching on the RDR52

When starting the device in DAB mode, a complete scan is always performed. This can take a long time and is annoying if no DAB is to be received at all. In the time between activation of the signal processing (appearance of 174,000,000.0 MHz in the frequency display) until the start of the DAB scan ("Search DAB..." in the display), the Menu button can be pressed (min. 2x tapping for proper detection). Opening the Menu will prevent the scan. Now, for example, another mode can be selected via the "Memory" dialog. Closing the menu with "Esc" continues the DAB start.

*Note:* As of version V215, as in all V4xx versions, no PNG images of the slide show can be displayed.

### FSK Decoder

The button "Decode" on the right side of the user interface switches through different decoders for "digital" modulations. A demodulator for Frequency Shift Keying (FSK) modulation is included in the Vx15 firmware. This modulation type is used for the transmission of binary data (e.g. text and image content) by various commercial broadcasters and in amateur radio. The type of information transmitted is very diverse, ranging from simple teletype ("RTTY") to sophisticated encodings including error correction mechanisms. Complex encodings (e.g. NAVTEX in SITOR-B method with Forward Error Correction) require increased computing effort and cannot be decoded internally in the RDR52 in this firmware version.

In version Vx15 the decoder can recognize and display the following encodings:

- ➔ ASCII: Standard 7 or 8 (restricted) bit format for displaying numbers, letters and special characters. This format is used on all common computer architectures for text display.
- ➔ Baudot (RTTY): 5 bit format to represent numbers, capital letters and some special characters. This format was developed for teletype and is used in radio traffic mainly for general transmissions ("broadcast") and amateur radio. Example: Weather reports of the German Weather Service DWD.
- ➔ Binary (HEX): 8-bit format for transmitting binary data in the form of bytes (1 byte = 8 bits). The data can have any meaning (e.g. program code or measured values). Example: Ripple control transmitter DCF39/49 for remote control of lighting / heating and similar equipment of large operators. Binary data is displayed in hexadecimal notation (digits / letters 0-9 and A-F).

**Caution!** For the FSK decoder's correct function the audio resolution has to be set to 20 Hz in the Setup dialog!

### Operation

The decoders of the RDR52 are configured via a dialog.

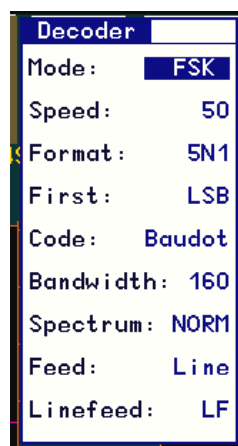

This dialog is opened by tapping the black decoder field under the "Decode" button. The field shows the

currently selected decoder (top) and the data speed measured when receiving a corresponding station (e.g. bit rate or CW speed). The measurement is not very accurate and depends on many factors such as internal sampling rate, SNR of the reception, etc. However, it can give a clue for setting the correct decoding speed if the parameters of the transmitter are completely unknown.

The dialog for configuring the FSK decoder has the following set values:

- **Mode:** Type of decoder. FSK, not adjustable.
- **Speed:** The bit rate in bit/s (also called "baud") of the modulation. Adjustable in 5 bit/s steps from 5 to 1275 bit/s.

**Note:** If "45" is set, the value 45.45 baud is used internally for the usual amateur radio speed!

- **Format:** The serial format of a character. A character consists of a number of data bits (1. digit), one or no parity bit (letter: N = none, E = even, O = odd) and one or 2 stop bits (2nd digit). All common formats with 5, 7 or 8 data bits, all possible parities and 1 or 2 stop bits are selectable.
- **First:** Data alignment LSB first or MSB first. LSB first is used almost exclusively.
- **Code:** ASCII, Baudot or Hex, as described above.
- **Bandwidth:** The spectral lines of the spectrum-based signal processing of the RDR52 used by the decoder (see explanations below). It should correspond approximately to the distance of the spectral lines of the FSK signal (readable in the spectrum) and should not be more than double of it. Selectable in steps of doubling / halving each from 40 Hz/bin to 5120 Hz/bin.
- **Spectrum:** NORM(al) or INV(erse) depending on the assignment of mark and space of the signal (right and left side of the spectrum, respectively) to high and low of the bit significance.
- **Feed:** Display of characters in the text lines above the spectrum diagram (see explanations below). Options are "Line" = line feed or "Char" = character feed (scrolling text).
- **Linefeed:** Character that triggers a line feed in hexadecimal display (set value "Code") and line feed (set value "Feed"). With ASCII or Baudot encoding, the characters assigned in the corresponding alphabet for Linefeed (LF) and Carriage Return (CR) are always used, **not** the character set here. Adjustable from 00 (decimal value 0) to FF (decimal value 255).

When the decoder is switched on, the spectrum diagram is reduced in height and 2 lines of text are displayed in the free space. Each line is 62 characters long. As soon as a character has been decoded, it is displayed in the bottom line. The representation of the already existing characters is managed according to two possible methods:

- ➔ Character feed (setting "Char" in the dialog). The new character will appear on the far right and the existing characters will be moved one position to the left. Characters from the bottom line are pushed out to the left and into the top line to the right. The effect corresponds to a scrolling text, as known from billboards, for example.
- ➔ Line feed (setting "Line" in the dialog). New characters are entered starting from the left until the bottom line is full or a line feed character is detected. As soon as another character has been decoded, the lower line is completely copied into the upper one and the display of the lower line starts again from the left. The effect is similar to writing text on a typewriter or on the screen of a PC.

Both variants have their advantages and disadvantages and can be chosen according to different requirements or tastes. With the character feed, the maximum possible number of characters is always visible before the oldest characters disappear at the top left, while with the line feed, in extreme cases, only one line could contain characters. However, at higher transmission speeds, reading the ticker is more difficult than reading a static line.

The display of the characters and the triggering of a line feed depends on the encoding set in the dialog (and of course the one sent by the transmitter). Below two examples for RTTY / Baudot (ASCII looks accordingly, lower case and more special characters are however possible), and for binary transmissions with hexadecimal display (line feed at block end character "16h" of DCF39).

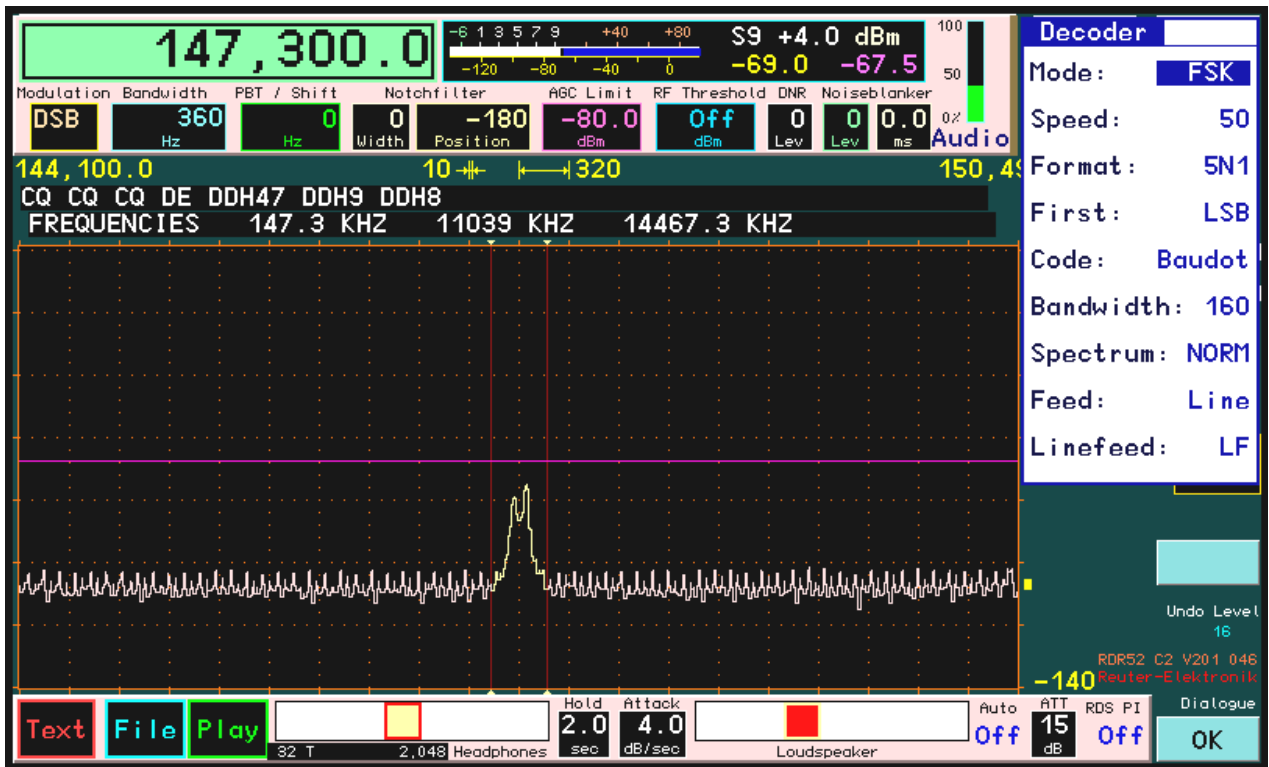

Decoding of DDH47 on 147.3 kHz

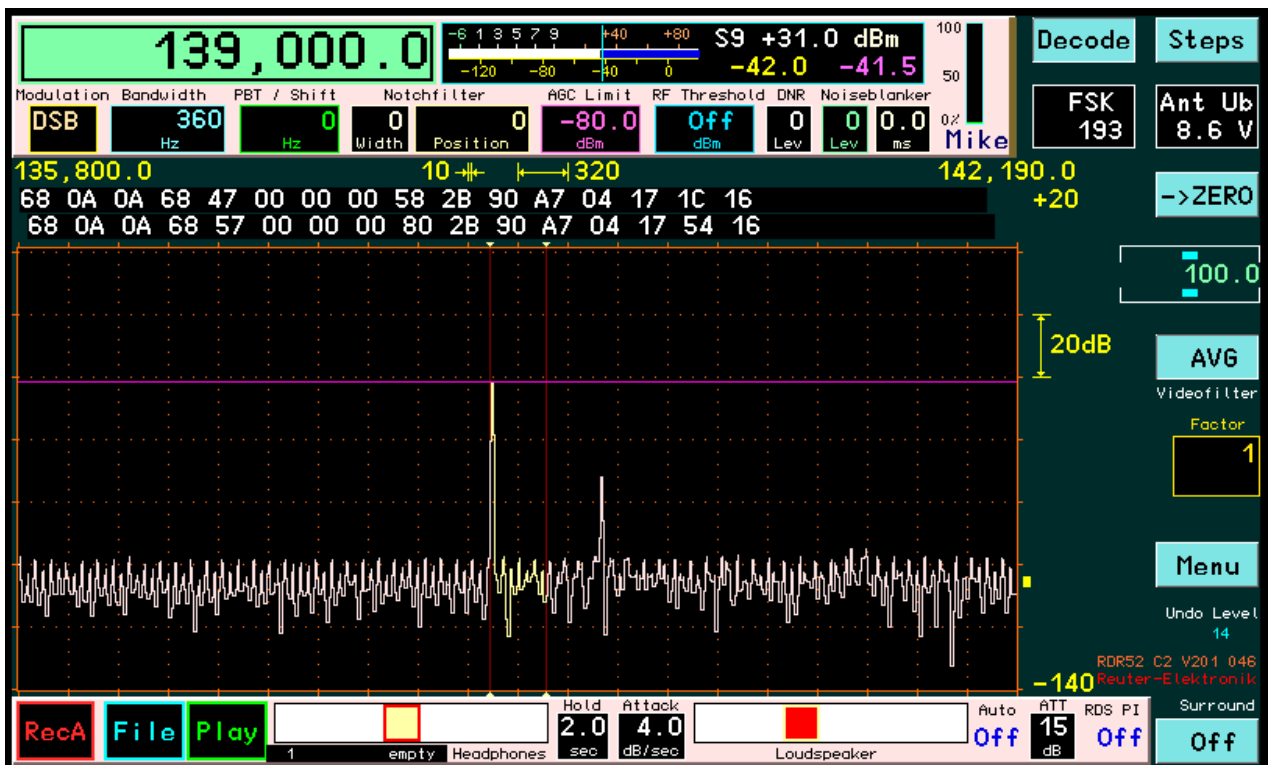

Decoding of DCF39

#### Further notes on reception

The FSK decoder operates in the RDR-specific "SBSP" mode. It therefore does not use a conventional FSK (audio) decoder for the mark and space tones of the signal. Instead, the information present in the spectral lines is used directly to demodulate the signal. To do this, the RDR52 must be set to the "SYNC" or "DSB" demodulators. Adjustments like sideband position (if necessary, the spectrum can be inverted in the dialog), shift settings or pitch selection are not required. The RDR52 can and must be set directly to the nominal transmit frequency (corresponds to the middle between the two tones).

*Note:* The demodulator "DIGI" is not suitable for the internal decoder. It is used to output demodulated I/Q signals to external decoders via the headphone jack.

All parameters for "usual" audio reception like bandwidth, shift, notch filters, interference suppression systems or spectrum settings have no effect on the decoder. However, if you want to listen to the signal acoustically, they can and must be set as desired / required.

In order for the decoder to select the appropriate spectral lines for demodulation of the signal, a bandwidth setting is necessary in the dialog. This has nothing to do with the bandwidth setting in the user interface (yellow "listening area"). The necessary setting depends on the "Shift" or "Hub" parameter of the transmitted signal (spacing of the tones, visible as the distance of the "humps" in the spectrum). It should be approximately in the range of the pitch to twice it. Example DDH47 with  $\pm 42.5$  Hz stroke = 85 Hz pitch: Suitable bandwidths are 80 Hz and 160 Hz.

The RDR52 allows only discrete bandwidths to be selected. However, the SBSP demodulator of the FSK decoder is very tolerant of bandwidths that do not fit exactly. However, if the signals are too far outside the bandwidth (tone spacing significantly larger than selected bandwidth), or if it is very large compared to the tone spacing (insufficient separation of the two signals), correct decoding is no longer possible. No or "nonsensical" characters will then appear in the display.

This also happens when no FSK signal is received, it has too little signal-to-noise ratio, or there is too much interference in the signal. Depending on the reception situation, a slight optimization can possibly be achieved with a bandwidth that is a little too small or a little too large.

#### Storage of the received characters

In the ideal case (character feed), the last 124 characters received are always visible in the display. All older ones are irretrievably lost. If you want to save the characters, you can use the RDR52's integrated flash recorder. For this purpose, the recording mode in the Recorder dialog can be switched to "TXT" mode for text files in addition to audio, I/Q, or image (option "Screendump") data. In this case, all received characters are saved after pressing "RecT" (in the dialog, or at the bottom left of the user interface).

However, the memory is not designed for single static data, but for a continuous data stream (audio or video data). That is why the text storage function has a few special features:

- ➔ The smallest possible amount of memory is 2048 or 4096 characters (depending on the type of built-in memory). So a file is always minimum this size, even if there is only one character in it. The rest consists of "empty data" (hexadecimal FF).
- ➔ It is always saved in blocks with the minimum size. Only when a block is full and stored is it "non-volatile", i.e. safe in flash memory. Until then, the data is in the RAM and is lost when the device is switched off (power failure). Stopping the recording, of course, saves everything immediately and thus safely.
- ➔ The minimum file size (individually erasable unit, which is also displayed in the memory consumption), is always 256 / 512 kByte. A text file in the Recorder dialog is thus always at least this large, even if there is only a single character (in a single 2048 / 4096 byte block). (With at least 512 MByte built-in memory, however, this is enough for "endlessly" long texts).

Of course, you can also get the files back into a PC as text. Therefore there is an update of the PC service program to version "RDR51G.EXE". As always, first insert the list on the Recorder tab and then click on the desired file. If it is a text file ("T" in front of it), the decompressor checkmark is called "Decompress to TXT". In this case the file is saved as a normal ASCII text file (readable with any editor). Baudot is converted to ASCII, just like it can be read in the lines of the RDR51. Without check mark or with decoder format "Hex" is always saved as a binary file. The files contain the blocks, which are always multiples of 2048 / 4096 characters. If there are less text characters in it, the rest is "FF" (delete in the editor if necessary).

The FSK decoder is a paid software option. An unlock code must be entered for activation. Without activation, the decoder displays a maximum of 620 characters and then stops working.

## 14.4 Vx16

The firmware versions RDR52AV216 (devices without transmitter / exciter) and RDR52AV416 (devices with exciter module C4) contain functional enhancements as well as minor bug fixes. This includes the new RDR52WLANVB0 WLAN driver.

New features:

### Changed adjustment options of the FSK demodulator

The Demodulator setup dialog has been changed to allow improved settings.

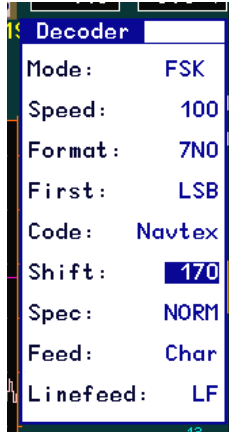

- **Before: Bandwidth, Now: Shift (in Hz):** The spectral lines of the RDR52's spectrum-based signal processing used by the decoder are now selected based on this parameter, which is common for FSK demodulation. The shift is the absolute distance of the two signal tones, i.e. the sum of the respective distance of the tone of the lower frequency and the tone of the higher frequency from the center of the spectrum. The value is sometimes signed for the individual tones (e.g.  $\pm 100$  Hz  $\rightarrow$  corresponds to 200 Hz shift), but mostly directly unsigned as a shift value.
- **Spec(trum):** New: Possibility to set a halved spectrum width "NORM/2" or "INV/2". This corresponds to processing the signals with only half of the actually required bandwidth. This requires a somewhat higher signal-to-noise ratio of the received signal for error-free decoding, but allows a much stronger suppression of interfering signals that may be close to the received signal. This setting can therefore be advantageous if there is actually enough SNR for decoding, but closely spaced discrete interference signals make successful decoding difficult or even impossible.

### Extension of the text display

The maximum number of characters that can be displayed by the decoder is now 186 characters (62 characters each in 3 lines).

### NAVTEX decoder for the FSK demodulator

The FSK demodulator was extended by a decoder for receiving Navtex transmissions. These transmissions are sent in a special code format (SITOR-B). This format is not decodable with the conventional decoders for RS-232 compatible formats (consisting of start bit, data bits, possible parity bit and 1 or 2 stop bits). Therefore, an additional stand-alone decoder for Navtex was configured in the RDR52's hardware (within the FPGA). It is activated when the newly added "Navtex" value is selected for the "Code" setting in the FSK demodulator setup. All necessary other set values are also adjusted in the process. The choice of bitrate, shift and spectrum remain freely available and must be set to the correct values:

- Speed: 100 Baud
- Shift: 170 Hz
- Spectrum: NORM or NORM/2

Due to the special code format, Navtex transmissions cannot be decoded arbitrarily at any time. Unlike RS-232 compatible formats, where the decoder can recognize and decode each character individually, Navtex requires special synchronization to recognize the character string. For this purpose, so-called synchronization characters are sent out at the beginning of each message. If the decoder recognizes these characters, it starts (and only then!) decoding and displays the recognized text characters. So, if necessary, when tuning in a Navtex transmitter and receiving the beeps, you have to wait until the transmitter sends synchronization characters and the text display of the decoder starts.

*Note:* In rare cases, the decoder may suspect synchronization in noisy / garbled characters and output (nonsensical) characters for a while.

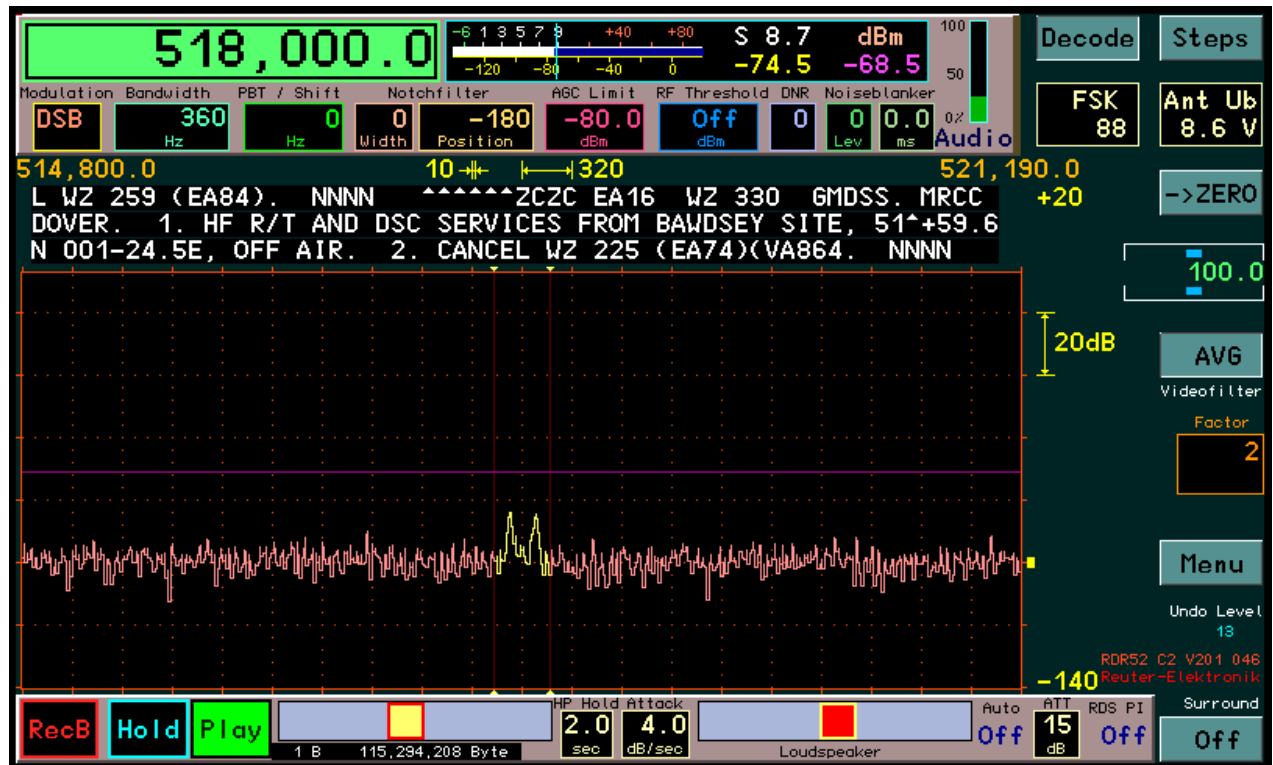

*Note:* Navtex has a built-in capability for partial detection and correction of incorrectly received characters. If an erroneous character has been detected, but correction is not possible (the correction character sent along is also erroneous), the decoder outputs the character "^" for recognition.

## Up / download of files

The RDR52 can store recordings of the baseband data (complex IQ data) in the flash recorder. Depending on the selected bandwidth, this data requires a lot of storage space. Recordings can be transferred to a connected PC via WiFi and saved to files there. The storage on the PC can be done in a RDR specific compressed format (binary file with extension .HEX) or decompressed as .WAV file (see also section 7.5 "File download").

WAV files containing IQ data (not audio signals) are playable with special software ("SDR programs"). For this purpose, the programs require an indication of the sample rate and the frequency at which the data was recorded. This information is stored in the recorder for IQ data and sent with the transfer to the PC. When saving a file, the file name is now generated accordingly:

"File" with consecutive number according to list in recorder + sample rate + frequency

Up- and download of files in this format is possible with the PC software from version RDR51H2.EXE.

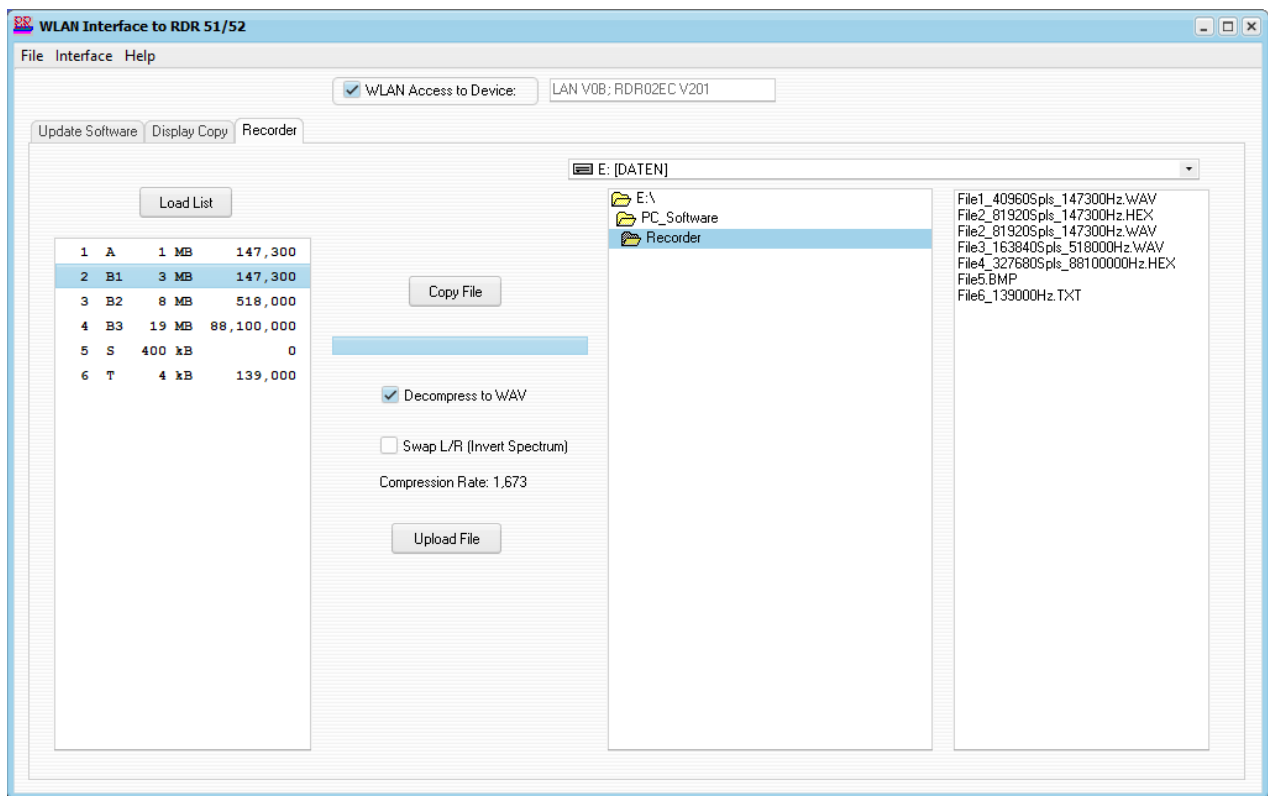

### Examples of files with different sampling rates and frequencies

Based on this information in the file name, some SDR programs can automatically set the playback. For other programs, the sample rate and reception frequency must be entered manually.

*Note:* Image files (file 5 in the example) do not contain information about frequencies or sampling rates, text files (file 6) only contain the reception frequency at which text was recorded by the decoder.

*Note:* The numbering of the saved files has been changed compared to the original description in section 7.5 and now corresponds exactly to the entries in the Recorder dialog or the list read from it. The file labels in the Recorder dialog and the small file display below the volume control for the headphones have also been adjusted accordingly.

When decompressing and saving as a WAV file, the assignment of the I and Q data to the Left and Right audio channels can be swapped by activating the "Swap L/R (Invert Spectrum)" switch. This may cause the sideband position to be reversed during playback if it is not displayed correctly in the SDR program. This works only with WAV files, swapping is not possible (and not necessary) with the RDR's own binary format (.HEX).

HEX files can also be loaded back from the PC into the RDR52 and played there. To do this, select the corresponding file on the right and start the upload with the "Upload File" button. The loading can take quite a long time depending on the file size, you should provide for a stable WiFi environment and do not burden the PC with the execution of other programs!

**Caution!** This firmware update contains some fundamental hardware and software changes. The structures of the memory slots and the files for the flash recorder have been changed. Important recordings should be backed up on a PC before updating the firmware! When calling up memory slots, unexpected settings of the device may occur! In this case, the RDR52 should be reset to the factory settings (Dialog "System" → "Undo to Level" → 0) and the memory slot deleted or reassigned with the desired settings.



## 14.5 Vx17

The firmware versions RDR52AV217 (devices without transmitter / exciter) and RDR52AV417 (devices with exciter module C4) contain significant functional enhancements. These include the new WLAN driver RDR52WLANVCx (x = consecutive number).

**Caution!** This firmware update contains some fundamental hardware and software changes. The structures of the memory slots and the files for the flash recorder have been changed. Important recordings should be backed up on a PC before updating the firmware! When calling up memory slots, unexpected settings of the device may occur! In this case, the RDR52 should be reset to the factory settings (Dialog "System" → "Undo to Level" → 0) and the memory slot deleted or reassigned with the desired settings.

### New features

- Remote control via WiFi

Remote adjustability of all variable set values has been implemented, both on the user interface and in the dialogs. Each value can be changed by a command received via TCP/IP over WiFi.

- Data and signal output via WiFi

When a set value is adjusted on the RDR52 (in the user interface or in a dialog), the adjusted value is sent as a TCP/IP packet via WiFi. Raw data from the device's AD converter can be sent as a continuous stream of data packets. The data packets contain complex (I/Q) data with 24-bit resolution and 81,920 samples/s sampling rate.

These functions allow the RDR52 to be fully remote controlled and used as an "SDR" (RF input for a personal computer) to use the data in a SDR program. In this firmware version, only the remote control functions for the settings required for SDR operation are used (e.g. frequency setting or attenuator). All other setting options are not required as they are usually available in the SDR program itself (e.g. demodulator or bandwidth).

A Windows DLL file (ExtIO\_RDR5xA.DLL) serves as a link between the WiFi network with the connected computer and the RDR52 on the one hand and a user software (SDR program) on the other. It allows access to various functions for controlling the RDR52 and transferring IQ data from the WiFi connection. The structure of the functionality follows the quasi-standard of the "ExtIO" DLL according to Alberto di Bene. Any SDR program that supports coupling to a specific hardware via ExtIO DLL can therefore also be used to connect to the RDR52.

**The operation of the RDR52 with SDR programs via WiFi is to be regarded as "experimental" and work in progress! Satisfactory results can only be achieved with a perfect WiFi connection!**

To upload the new firmware and establish a connection to an SDR program, proceed as follows:

- Upload the WLAN driver RDR52WLANVCx.BIN and the firmware RDR52AV217.RPD or RDR52AV417.RPD (with or without transmitter, depending on the device version) into the RDR52 (using the program "RDR51xx.EXE" for Windows, xx depending on the current version). A possible warning that the firmware loaded is too old can be ignored (results from the different names "AV..." or "CV..." of older and newer versions).

- Setting the RDR52 for "SDR" operation:

- Activate the access point in the WiFi dialog (possibly set automatic activation when switching on in the Setup). **Never activate release driver update!**
- Demodulator FM-W
- Log any additional devices used (RSW3/4 control units for RLA4 antennas, RAP1 preselector) into the RDR52 access point if they are also to be controlled via WiFi.
- Log the computer into the access point of the RDR52 (like you do for a firmware update).
- Copy the ExtIO\_RDR5xA.DLL file into the directory of the SDR program used (e.g. HSDR).
- Start the program and select the DLL as the signal source / hardware connection (usually only necessary once).

If the connection is successfully established, the RDR52 data will appear in the program displays (spectrum / waterfall). Frequency tuning in the program is carried out in sync with the RDR52. Bidirectional operation is possible: Changes in the SDR program are executed and displayed on the RDR52, changes on the RDR52 (rotary knob) are transferred to the SDR program. This means that the program can also be tuned using the rotary knob on the RDR52 instead of the PC's keyboard and mouse.

In addition, a control panel for important RDR52 settings is displayed on the computer's display (may need to be enabled or made visible in the program).

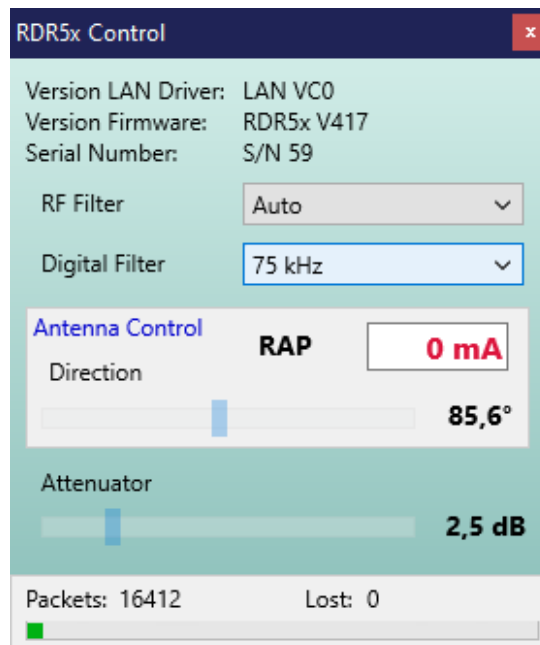

The following displays and settings are available in the panel:

- Displays the version of the WLAN driver and the firmware in the RDR52 as well as the serial number of the device.
- RF filter (analog filter before ADC): The setting corresponds to the possibilities of the corresponding "Filter Bandpass" value in the Setup of the RDR52 (with the exception of the DAB range).
- Selection of the digital filter after the ADC to limit the IQ bandwidth. The IQ data is transmitted at a sampling rate of 81.92 kSpl/s. This results in a theoretically possible bandwidth of 81.92 kHz, with zero aliasing attenuation at the band boundaries. Depending on the steepness of the digital filter, a more or less large area at the band boundaries is affected by aliasing interference. The digital filter uses the existing FM-W filters of class "S" (sharp or steep) 38 kHz in the RDR52. 50 kHz, 75 kHz and 140 kHz. Up to 75 kHz there is good to sufficient aliasing attenuation, 140 kHz is only useful if reception is to take place directly at the band boundaries and no aliasing interference ("mirror frequencies") is present.
- Antenna Control: Display of the antenna control activated in the RDR52's Setup, when using an RSW3/4 or RAP1 connected via WiFi also the measured antenna current. An existing RLA4 can be operated remotely using the "Direction" slider.
- Attenuator: The RDR52's attenuator. In contrast to the device (1 dB resolution), the value can be set in 0.5 dB steps via software. The level difference between IQ data and the display of the RDR52 is 3.0 dB. For this reason, a setting of -3.0 ... 28.5 dB is possible in the remote control panel in the same way as 0 ... 31 dB in the RDR52.
- Display of the data packets received since the start of data transmission via WiFi (each contains 1024 samples) and the lost data packets.
- Fill level indicator of the buffer for data packets in the event of a briefly interrupted connection.

### Further information on operating the RDR52 with SDR programs

The RDR52's WiFi connection to a computer allows complete galvanic isolation of the devices (no interference signal transmission) and a certain flexibility in the positioning of the devices (no cables). However, this comes at the price of fundamentally less reliable data transmission. In particular, the WiFi

frequency range around 2.4 GHz used in the RDR52 is often already occupied by several access points in the house and in the neighborhood. In addition, there is broadband interference from nearby electronic devices, microwave ovens, etc.

This susceptibility to interference and unreliability of cable connections manifests itself in more or less frequent data loss. The lost packets are displayed in the RDR52 control panel. The loss of a few packets should be rare. Otherwise the connection will be too impaired and the usability of the SDR program will be severely restricted by too frequent interference.

There are several ways to optimize the WiFi connection. Here are a few general rules:

- Switch the access point of the RDR52 to a channel that is used as little as possible (can be checked with auxiliary programs in the WiFi router or smartphone app).
- Align the antennas of the computer WiFi module and the RDR52 optimally. Do not set up devices too far (HF level too low) or too close (overmodulations possible) to each other.
- Switch off or shield internal and external sources of interference as far as possible.
- Design the power supply for the computer and RDR52 to minimize interference, suppress interference in the cable connections on the RDR52 and especially on the computer (hinged ferrites or similar).

Another common cause of data loss is the computer itself. It must offer sufficient computing power to operate all running programs **AND** the WLAN driver without delay. The data packets must be received at a constant rate of 12.5 ms (80 packets per second, around 4.4 Mbit/s). If delays occur (operating system does not allocate enough computing time often enough), only a few packets can be buffered in the RDR52 and transmitted later at a higher speed. Interruptions longer than approx. 0.2 s lead to data loss.

Background programs such as virus scanners, update managers, firewalls etc. often interfere with the data connection because they require access to the WiFi connection. The desired connection to the SDR program is also usually "optimized" several times by the operating system after start-up, during which short connection interruptions occur. These effects are increasingly reduced over the operating time of the program.

The RDR52 should be set up appropriately before starting the connection / the SDR program (switch off antenna configuration, display / volume if necessary, etc.). Although it remains fully operable while the connection is active, discrepancies may occur between the device settings and the settings in the SDR program. The RDR52 should therefore not be operated while connected to an SDR program. The exception is the adjustment of parameters (especially frequency), which can also be adjusted from the computer (bidirectional adjustment of settings).

The digital filter settings can only be made correctly if all FM filters of the RDR52 are enabled (paid option). Otherwise, the nearest filter of the RDR52 is used (note the display on the RDR52!).

**Remote control including connection to SDR programs via the supplied ExtIO DLL are free additional options of the RDR52. No guarantee is given for its complete and error-free operation, as all conditions outside the RDR52 (especially WiFi connection, computer and software running on it) cannot be influenced. Do not use these functions in data-critical applications or applications that may be dangerous to property or people!**